

# 卡套接头



卡套接头

VCR接头

焊接接头

通用阀门

高纯阀门

卡套管

技术信息

## 产品目录

	联合接头 -2-X P5		O圈密封NPT接头 -2-X-YNTO P5		NPT外螺纹弯头 -9-X-YNT P5
	变径联合接头 -2-X-Y P5		卡套管承插焊接头 -2-X-YTW P5		RT外螺纹弯头 -9-X-YRT P5
	穿板联合接头 -7-X P5		公称管外焊接头 -2-X-YPW P5		PR平行螺纹弯头 -2-X-YPR- P5
	变径穿板联合接头 -7-X-Y P5		NPT内螺纹连接接头 -2-X-YFNT P5		ST直螺纹弯头 -9-X-YST P5
	NPT外螺纹接头 -2-X-YNT P5		RT内螺纹连接接头 -2-X-YFRT P5		卡套管承插焊弯头 -9-X-YTW P5
	穿板NPT外螺纹接头 -7-X-YNT P5		RG内螺纹连接接头 -2-X-YFRG P5		公称管外焊弯头 -9-X-YPW P5
	ISO/BSP锥形螺纹 RT外螺纹接头 -2-X-YRT P5		穿板NPT内螺纹连接接 头 -7-X-YFNT P5		NPT内螺纹弯头 -9-X-YFNT P5
	ISO/BSP锥形螺纹 RS外螺纹接头 -2-X-YRS P5		卡套管变径接头 -2-X-YTB P5		NPT外螺纹45°弯头 -5-X-YNT P5
	ISO/BSP锥形螺纹 RP外螺纹接头 -2-X-YRP P5		孔口连接接头 -6-X P5		ST直螺纹45°弯头 -5-X-YST P5
	SAE/MS直螺纹 (ST) 接头 -2-X-YST P5		变径孔口连接接头 -6-X-Y P5		三通联合接头 -3-X P5
	AN外螺纹接头 -2-X-YAN P5		管帽 -C-X P5		三通变径联合接头 -3-X-Y-Z P5
	AN外螺纹穿板接头 -7-X-YAN P5		堵头 -P-X P5		NPT外螺纹三通 -3-X-Y-ZNT P5
	O圈密封SAE/MS直螺 纹接头 -2-X-YSTO P5		弯头 -9-X P5		SAE/MS直螺纹 (ST) 三通接头 -3-X-Y-ZST P5

卡套接头

VCR接头

焊接接头

通用阀门

高纯阀门

卡套管

技术信息

	ISO/BSP平行螺纹 (PR) 三接头 -3-X-Y-ZPR P5		ISO平行内螺纹 (RG) 卡套管转换接头 -2-XTB-YFRG P5
	NPT内螺纹三通接头 -3-X-Y-ZFNT P5		AN内螺纹卡套管转换 接头 -2-XTB-YFAN P5
	四通接头 -4-X- P5		不锈钢螺母 -N-X- P5
	NPT外螺纹卡套管转接 头 -2-XTB-YNT P5		前卡套 -FF-X- P5
	RT锥螺纹卡套管转接 头 -2-XTB-YRT- P5		后卡套 -BF-X- P5
	RS螺纹卡套管转换 头 -2-XTB-YRS		螺母卡套组 -NFS-X- P5
	RP平行螺纹卡套管转 接头 -2-XTB-YRP P5		卡套组 -FS-X- P5
	ST螺纹卡套管转换 头 -2-XTB-YST P5		软塑料卡套管插件 -Z-X-Y P5
	O型圈密封卡套管转换 接头 -2-XTB-YSTO P5		
	AN螺纹卡套管转换接 头 -2-XTB-YAN P5		
	NPT内螺纹卡套管转换 头 -2-XTB-YFNT P5		
	RT锥形内螺纹卡套管 转换头 -2-XTB-YFRT P5		
	ISO平行内螺纹 (RP) 卡套管转换接头 -2-XTB-YFRP P5		

## 特征

- ◆尺寸从英制：1/16"到2"，以及公制：2mm到50mm
- ◆有多种材质和结构形式
- ◆易于正确安装、拆卸和重新紧固
- ◆首次安装具有可检测性。
- ◆双卡套设计，提供极佳的气体密封和卡套管：夹紧。
- ◆安装时不会将扭矩传递到卡套管上。
- ◆具有极好的抗振动疲劳性能和卡套管支撑性能。
- ◆可靠的复装，多次重复使用
- ◆与相同尺寸、相同材质的标准卡套接头：兼容。

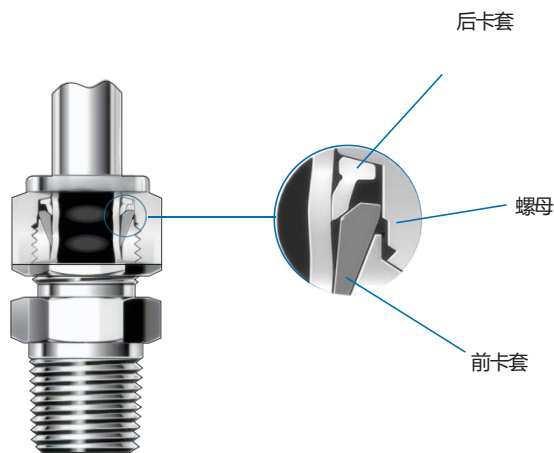

### 如何订购材料?

选择一个基本订购号，例如 -2-6M

再加上一个材料代号，例如 **SS**-2-6M。

材料	代号	材料	代号
316不锈钢	SS	合金 2507	2507
合金 400	M	合金 C-276	HC
合金 625	625	6-Moly	254

### 基本订购号信息

基本订购号包含接头形式、接头尺寸：等信息，例如 -2-6M。

第一个“-”后为接头类型：，第二个“-”及以后每一个“-”后面描述为尺寸和接头规格。

接头类型	代码:	公制 接头尺寸	代码	英制 接头尺寸	代码	接头规格	代码	接头规格	代码
直通:	2	2	2M	1/16	1	卡套管短接	TB	/	/
三通:	3	4	4M	1/8	2	NPT外螺纹	NT	NPT内螺纹	FNT
四通:	4	6	6M	1/4	3	RT外螺纹	RT	RT内螺纹	FRT
45°弯头:	5	8	8M	3/8	6	ISO/BSP外螺纹 (RS)	RS	ISO/BSP内螺纹 (RS)	FRS
孔口接头:	6	10	10M	1/2	8	ISO/BSP外螺纹 (RP)	RP	ISO/BSP内螺纹 (RP)	FRP
穿板:	7	12	12M	3/4	12	ISO/BSP外螺纹 (RJ)	RJ	ISO/BSP内螺纹 (RJ)	FRJ
弯头	9	14	14M	1	16	ISO/BSP外螺纹 (RG)	RG	ISO/BSP内螺纹 (RG)	FRG
管帽:	C	16	16M	1 1/4	20	SAE/MS直螺纹	ST	/	/
堵塞:	P	18	18M	1 1/2	24	O型圈密封SAE/MS螺 纹	STO	/	/
前卡套:	FF	20	20M	2	32	O型圈密封NPT螺纹	NTO	/	/
后卡套:	BF	22	22M			可定位ISO/BSP平行螺 纹 (PR) :	PR	/	/
螺母:	N	25	25M			AN外螺纹接头:	AN	AN内螺纹接头:	FAN
卡套组:	FS	28	28M			卡套管承插焊接头:	TW	公称管对焊	PW
卡套螺母组:	NFS	30	30M			卡套螺母组	NFS	/	/
塑料卡套管插件:	Z	32	32M						
排放保护器:	D	38	38M						
本体:	B	50	50M						

### 双卡套的机械式抓紧设计

双卡套将密封功能和卡套管的抓紧功能分开，每个卡套都针对其相应的功能进行了设计

前卡套形成密封:

- ◆与接头本体间密封
- ◆与卡套管外径间密封

旋紧螺母后卡套产生作用:

- ◆轴向推进前卡套
- ◆径向施加一个有效的卡套管抓紧作用

# 基本订购号

## 联合接头 (英制, 公制)

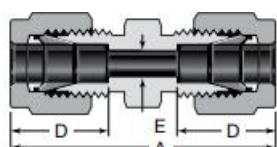

## 变径联合接头 (公制转英制)

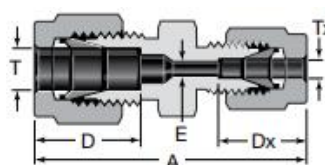

卡套管 外径	基本订购号	尺寸		
		A	D	E
英制尺寸, mm				
1/16	-2-1	25.1	8.6	1.3
1/8	-2-2	35.6	12.7	2.3
3/16	-2-3	37.3	13.7	3.0
1/4	-2-4	40.9	15.2	4.8
5/16	-2-5	42.9	16.2	6.4
3/8	-2-6	45.0	16.8	7.1
1/2	-2-8	51.3	22.9	10.4
5/8	-2-10	52.1	24.4	12.7
3/4	-2-12	53.6	24.4	15.7
7/8	-2-14	55.1	25.9	18.3
1	-1-16	64.8	31.2	22.4
1 1/8	-2-20	64.8	31.2	24.6
1 1/4	-2-24	92.2	41.1	27.7
1 1/2	-2-32	108	50.0	34.0
公制尺寸, mm				
2	-2-2M	35.6	12.9	1.7
3	-2-3M	35.3	12.9	2.4
4	-2-4M	37.3	13.7	2.4
6	-2-6M	41.0	15.3	4.8
8	-2-8M	43.2	16.2	6.4
10	-2-10M	46.2	17.2	7.9
12	-2-12M	51.2	22.8	9.5
14	-2-14M	52.0	24.4	11.1
15	-2-15M	52.0	24.4	11.9
16	-2-16M	52.0	24.4	12.7
18	-2-18M	53.5	24.4	15.1
20	-2-20M	55.0	26.0	15.9
22	-2-22M	55.0	26.0	18.3
25	-2-25M	65.0	31.3	21.8
28	-2-28M	85.0	36.6	21.8
30	-2-30M	92.7	39.6	26.2
32	-2-32M	97.3	42.0	28.6
38	-2-38M	113.6	42.9	33.7

卡套管外径		基本订购号	尺寸				
T	Tx, in.		A	D	Dx	E	F
尺寸, mm							
3	1/8	-2-3M-2	35.2	12.9	12.7	2.4	12
4	1/8	-2-4M-2	36.5	13.7	12.7	2.4	12
	1/4	-2-4M-4	39.4	13.7	15.2	2.4	14
6	1/8	-2-6M-8	38.5	15.3	12.7	2.4	14
	1/4	-2-6M-4	41.0	15.3	15.2	4.8	14
8	5/16	-2-6M-5	42.3	15.3	16.2	4.8	14
	1/4	-2-8M-4	42.3	16.2	15.2	4.8	15
8	3/8	-2-8M-6	44.3	16.2	16.8	6.4	16
	10	1/8	-2-10M-2	41.8	17.2	12.7	2.4
1/4		-2-10M-4	44.5	17.2	15.2	4.8	18
5/16		-2-10M-5	45.1	17.2	16.2	6.4	18
10	3/8	-2-10M-6	45.9	17.2	16.8	7.1	18
	12	5/16	-2-12M-5	47.8	22.8	16.2	6.4
3/8		-2-12M-6	48.4	22.8	16.8	7.1	22
12	1/2	-2-12M-8	51.2	22.8	22.9	9.5	22
	15	1/2	-2-15M-8	52.0	24.4	22.9	10.4
16	5/8	-2-16M-10	52.0	24.4	24.4	12.7	24
18	3/4	-2-18M-12	53.5	24.4	24.4	15.1	27
20	1/2	-2-20M-8	55.0	26.0	22.9	10.4	30
	1	-2-20M-16	62.8	26.0	31.2	15.9	35
25	1	-2-25M-16	65.0	31.3	31.2	21.8	35

## 变径联合接头 (英制, 公制)

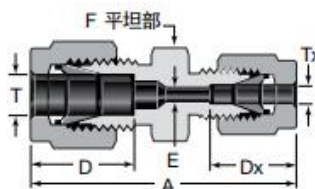

卡套管外径		基本订购号	尺寸			
T	Tx		A	D	Dx	E
英制尺寸, mm						
1/8	1/16	-2-2-1	31.0	12.7	8.6	1.3
3/16	1/16	-2-3-1	32.3	13.7	8.6	1.3
	1/8	-2-3-2	36.6	13.7	12.7	2.3
1/4	1/16	-2-4-1	34.3	15.2	8.6	1.3
	1/8	-2-4-2	38.6	15.2	12.7	2.3
	3/16	-2-4-3	39.4	15.2	13.7	3.0
5/16	1/8	-2-5-2	39.6	16.2	12.7	2.3
	1/4	-2-5-4	42.2	16.2	15.2	4.8
3/8	1/16	-2-6-1	36.6	16.8	8.6	1.3
	1/8	-2-6-2	40.9	16.8	12.7	2.3
	1/4	-2-6-4	43.2	16.8	15.2	4.8
	5/16	-2-6-5	44.2	16.8	16.2	6.4
1/2	1/8	-2-8-2	45.2	22.8	12.7	2.3
	1/4	-2-8-4	47.0	22.8	15.2	4.8
	3/8	-2-8-6	48.5	22.8	16.8	7.1
5/8	3/8	-2-10-6	49.3	24.4	16.8	7.1
	1/2	-2-10-8	52.1	24.4	22.8	10.4
3/4	1/4	-2-12-4	49.3	24.4	15.2	4.8
	3/8	-2-12-6	50.8	24.4	16.8	7.1
	1/2	-2-12-8	53.6	24.4	22.8	10.4
	5/8	-2-12-10	53.6	24.4	24.4	12.7
1	1/2	-2-16-8	60.5	31.2	22.8	10.4
	3/4	-2-16-12	60.5	31.2	24.4	15.7
公制尺寸, mm						
3	2	-2-3M-2M	35.3	12.9	12.9	1.7
6	2	-2-6M-2M	38.6	15.3	12.9	1.7
	3	-2-6M-3M	38.6	15.3	12.9	2.4
	4	-2-6M-4M	39.4	15.3	13.7	2.4
8	6	-2-8M-6M	42.3	16.3	15.3	4.8
10	6	-2-10M-6M	44.5	17.2	15.3	4.8
	8	-2-10M-8M	45.1	17.2	16.3	6.4
12	6	-2-12M-6M	47.0	22.8	15.3	4.8
	8	-2-12M-8M	47.8	22.8	16.3	6.4
	10	-2-12M-10M	48.7	22.8	17.2	7.9
16	10	-2-16M-10M	49.5	24.4	17.2	7.9
	12	-2-16M-12M	52.0	24.4	22.8	9.5
18	12	-2-18M-12M	53.5	24.4	22.8	9.5
25	18	-2-25M-18M	61.0	31.3	24.4	15.1
	20	-2-25M-20M	62.3	31.3	26.0	15.9
30	18	-2-30M-18M	75.4	39.6	24.4	15.1
	20	-2-30M-20M	75.4	39.6	26.0	15.9
	25	-2-30M-25M	80.1	39.6	31.3	21.8
32	18	-2-32M-18M	77.8	42.0	24.4	15.1
	20	-2-32M-20M	77.8	42.0	26.0	15.9
	25	-2-32M-25M	82.3	42.0	31.3	21.8
38	20	-2-38M-20M	87.5	49.4	26.0	15.9
	25	-2-38M-25M	92.0	49.4	31.3	21.8
	30	-2-38M-30M	104.6	49.4	39.6	26.2

卡套接头

VCR接头

焊接接头

通用阀门

高纯阀门

卡套管

技术信息

## 穿板联合接头 (英制, 公制)

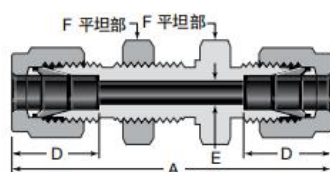

卡套管 外径	基本 订购号	尺寸					
		A	D	E	F	面板孔尺寸	最大面板厚度
英制尺寸, mm							
1/16	-7-1	31.5	8.6	1.3	7.9	5.2	3.0
1/8	-7-2	51.3	12.7	2.3	12.7	8.3	12.7
3/16	-7-3	53.6	13.7	3.0	14.3	9.9	12.7
1/4	-7-4	57.7	15.2	4.8	15.9	11.5	10.2
5/16	-7-5	60.7	16.3	6.4	17.5	13.1	11.2
3/8	-7-6	62.2	16.8	7.1	19.1	14.7	11.2
1/2	-7-8	71.1	22.9	10.4	23.8	19.4	12.7
5/8	-7-10	72.6	24.4	12.7	27.0	22.6	12.7
3/4	-7-12	79.0	24.4	15.7	30.2	25.8	16.8
7/8	-7-14	84.6	25.9	18.3	34.9	29.0	19.1
1	-7-16	95.8	31.2	22.4	41.3	33.7	19.1
1 1/4	-7-20	123.2	41.1	27.8	47.6	41.7	19.1
1 1/2	-7-24	139.2	50.0	34.0	57.2	49.6	19.1
公制尺寸, mm							
3	-7-3M	51.3	12.9	2.4	14	8.3	12.7
4	-7-4M	53.6	13.7	2.4	14	9.9	12.7
6	-7-6M	57.7	15.3	4.8	16	11.5	10.2
8	-7-8M	61.0	16.2	6.4	18	13.1	11.2
10	-7-10M	63.7	17.2	7.9	22	16.3	11.2
12	-7-12M	71.0	22.8	9.5	24	19.5	12.7
14	-7-14M	72.5	24.4	11.1	27	22.5	12.7
15	-7-15M	72.5	24.4	11.9	27	22.8	12.7
16	-7-16M	72.5	24.4	12.7	27	22.8	12.7
18	-7-18M	78.9	24.4	15.1	30	26.0	16.8
20	-7-20M	84.5	26.0	15.9	35	29.0	19.0
25	-7-25M	96.0	31.3	21.8	41	34.0	19.0
30	-7-30M	124.0	39.6	26.2	50	40.5	19.0
32	-7-32M	128.0	42.0	28.6	50	42.5	19.0
38	-7-38M	145.0	49.4	33.7	60	50.5	19.0

卡套接头

VCR接头

焊接接头

通用阀门

高纯阀门

卡套管

技术信息

## 变径穿板直通接头

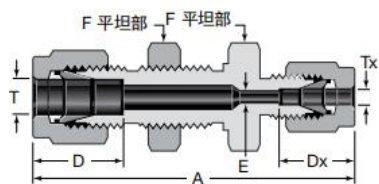

卡套管外径		基本订购号	尺寸						
T	Tx		A	D	Dx	E	F	面板孔尺寸	最大面板厚度
英制尺寸, mm									
1/4	1/8	-7-2-1	55.1	15.2	12.7	2.3	15.9	11.5	10.2
3/8	1/4	-7-4-2	60.7	16.8	15.2	4.8	19.1	14.7	11.2
1/2	1/4	-7-6-4	66.8	22.9	15.2	4.8	23.8	19.4	12.7

卡套管外径		基本订购号	尺寸						
T	Tx		A	D	Dx	E	F	面板孔尺寸	最大面板厚度
公制尺寸, mm									
6	3	-7-6M-3M	55.1	15.3	12.9	2.4	16	11.5	10.2
8	6	-7-8M-6M	60.1	16.2	15.3	4.8	18	13.1	11.2
12	8	-7-12M-8M	67.6	22.8	16.2	6.4	24	19.5	12.7

## NPT外螺纹接头 (英制)

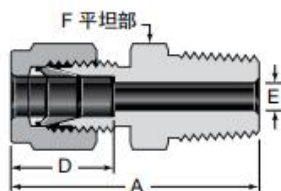

卡套管 外径	NPT 尺寸	基本订购号	尺寸			
			A	D	E	F
英制尺寸, mm						
1/16	1/16	-2-1-1NT	23.9	8.6	1.3	7.9
	1/8	-2-1-2NT	26.2	8.6	1.3	11.1
	1/4	-2-1-4NT	31.0	8.6	1.3	14.3
1/8	1/16	-2-2-1NT	29.7	12.7	2.3	11.1
	1/8	-2-2-2NT	30.5	12.7	2.3	11.1
	1/4	-2-2-4NT	35.6	12.7	2.3	14.3
	3/8	-2-2-6NT	35.8	12.7	2.3	17.5
	1/2	-2-2-8NT	42.2	12.7	2.3	22.2
3/16	1/16	-2-3-1NT	31.2	13.7	2.3	11.1
	1/8	-2-3-2NT	31.2	13.7	3.0	11.1
	1/4	-2-3-4NT	36.3	13.7	3.0	14.3
1/4	1/16	-2-4-1NT	32.8	15.2	3.0	12.7
	1/8	-2-4-2NT	32.8	15.2	4.8	12.7
	1/4	-2-4-4NT	37.8	15.2	4.8	14.3
	3/8	-2-4-6NT	38.4	15.2	4.8	17.5
	1/2	-2-4-8NT	44.7	15.2	4.8	22.2
	3/4	-2-4-12NT	46.2	15.2	4.8	27.0
5/16	1/8	-2-5-2NT	34.0	16.3	4.8	14.3
	1/4	-2-5-4NT	38.6	16.3	6.4	14.3
	3/8	-2-5-6NT	39.1	16.3	6.4	17.5
	1/2	-2-5-8NT	45.5	16.3	6.4	22.2
3/8	1/8	-2-6-2NT	35.3	16.8	4.8	15.9
	1/4	-2-6-4NT	39.9	16.8	7.1	15.9
	3/8	-2-6-6NT	39.9	16.8	7.1	17.5
	1/2	-2-6-8NT	46.2	16.8	7.1	22.2
	3/4	-2-6-12NT	47.8	16.8	7.1	27.0
	1	-2-6-16NT	47.0	16.8	7.1	34.9
1/2	1/8	-2-8-2NT	38.9	22.9	4.8	20.6
	1/4	-2-8-4NT	43.4	22.9	7.1	20.6
	3/8	-2-8-6NT	43.4	22.9	9.7	20.6
	1/2	-2-8-8NT	49.0	22.9	10.4	22.2
	3/4	-2-8-12NT	50.5	22.9	10.4	27.0
	1	-2-8-16NT	57.2	22.9	10.4	34.9
5/8	1/4	-2-10-4NT	44.2	24.4	7.1	23.8
	3/8	-2-10-6NT	44.2	24.4	9.7	23.8
	1/2	-2-10-8NT	49.0	24.4	11.9	23.8
	3/4	-2-10-12NT	50.5	24.4	12.7	27.0
3/4	3/8	-2-12-6NT	45.7	24.4	10.4	27.0
	1/2	-2-12-8NT	50.5	24.4	11.9	27.0
	3/4	-2-12-12NT	50.5	24.4	15.7	27.0
	1	-2-12-16NT	57.2	24.4	15.7	34.9
7/8	1/2	-2-14-8NT	50.5	25.9	11.9	30.2
	3/4	-2-14-12NT	50.5	25.9	15.7	30.2
	1	-2-14-16NT	57.2	25.9	18.3	34.9
1	1/2	-2-16-8NT	57.4	31.2	11.9	34.9
	3/4	-2-16-12NT	57.4	31.2	15.7	34.9
	1	-2-16-16NT	62.2	31.2	22.4	34.9
1 1/8	1	-2-18-16NT	62.2	31.2	22.4	41.3
1 1/4	1	-2-20-16NT	77.2	41.1	22.4	44.5
	1 1/4	-2-20-20NT	77.2	41.1	27.7	44.5
1 1/2	1 1/2	-2-24-24NT	88.9	50.0	34.0	54.0

卡套接头

VCR接头

焊接接头

通用阀门

高纯阀门

卡套管

技术信息

## NPT外螺纹接头 (公制)

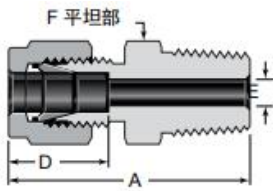

卡套管 外径	NPT尺寸 in.	基本订购号	尺寸			
			A	D	E	F
公制尺寸, mm						
2	1/8	-2-2M-2NT	30.5	12.9	1.7	12
3	1/8	-2-3M-2NT	30.5	12.9	2.4	12
	1/4	-2-3M-4NT	35.6	12.9	2.4	14
4	1/8	-2-4M-2NT	31.2	13.7	2.4	12
	1/4	-2-4M-4NT	36.3	13.7	2.4	14
6	1/8	-2-6M-2NT	32.8	15.3	4.8	14
	1/4	-2-6M-4NT	37.9	15.3	4.8	14
	3/8	-2-6M-6NT	38.4	15.3	4.8	18
	1/2	-2-6M-8NT	44.7	15.3	4.8	22
8	1/8	-2-8M-2NT	34.2	16.2	4.8	15
	1/4	-2-8M-4NT	38.7	16.2	6.4	15
	3/8	-2-8M-6NT	39.3	16.2	6.4	18
	1/2	-2-8M-8NT	45.6	16.2	6.4	22
10	1/8	-2-10M-2NT	36.3	17.2	4.8	18
	1/4	-2-10M-4NT	40.9	17.2	7.1	18
	3/8	-2-10M-6NT	40.9	17.2	7.9	18
	1/2	-2-10M-8NT	46.5	17.2	7.9	22
	3/4	-2-10M-12NT	48.0	17.2	7.9	27
	1	-2-10M-16NT	54.6	17.2	7.9	35
12	1/8	-2-12M-2NT	38.8	22.8	4.8	22
	1/4	-2-12M-4NT	43.4	22.8	7.1	22
	3/8	-2-12M-6NT	43.4	22.8	9.5	22
	1/2	-2-12M-8NT	49.0	22.8	9.5	22
	3/4	-2-12M-12NT	50.5	22.8	9.5	27
14	1/8	-2-14M-2NT	38.8	24.4	4.8	24
	1/4	-2-14M-4NT	44.1	24.4	7.1	24
	3/8	-2-14M-6NT	44.1	24.4	9.5	24
	1/2	-2-14M-8NT	49.0	24.4	11.1	24
	3/4	-2-14M-12NT	50.5	24.4	11.1	27
15	1/2	-2-15M-8NT	49.0	24.4	11.9	24
	3/4	-2-15M-12NT	50.5	24.4	11.9	27
	1	-2-15M-16NT	57.1	24.4	11.9	35
16	1/4	-2-16M-4NT	44.1	24.4	7.1	24
	3/8	-2-16M-6NT	44.1	24.4	9.5	24
	1/2	-2-16M-8NT	49.0	24.4	11.9	24
	3/4	-2-16M-12NT	50.5	24.4	12.7	27
18	3/8	-2-18M-6NT	45.6	24.4	9.5	27
	1/2	-2-18M-8NT	50.5	24.4	11.9	27
	3/4	-2-18M-12NT	50.5	24.4	15.1	27
20	1/2	-2-20M-8NT	52.3	26.0	11.9	30
	3/4	-2-20M-12NT	52.3	26.0	15.9	30
	1	-2-20M-16NT	57.1	26.0	15.9	35
22	1/2	-2-22M-8NT	52.3	26.0	11.9	30
	3/4	-2-22M-12NT	52.3	26.0	15.9	30
	1	-2-22M-16NT	57.1	26.0	18.3	35
25	1/2	-2-25M-8NT	57.5	31.3	11.9	35
	3/4	-2-25M-12NT	57.5	31.3	15.9	35
	1	-2-25M-16NT	62.3	31.3	21.8	35
28	1	-2-28M-16NT	72.4	36.6	21.8	41
	1 1/4	-2-28M-20NT	73.1	36.6	21.8	46
30	1 1/4	-2-30M-20NT	77.2	39.6	26.2	46
32	1 1/4	-2-32M-20NT	79.6	42.0	28.6	46
38	1 1/2	-2-38M-24NT	91.6	49.4	33.7	55

卡套接头

VCR接头

焊接接头

通用阀门

高纯阀门

卡套管

技术信息

## 穿板NPT外螺纹接头

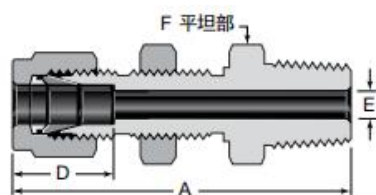

卡套管 外径	NPT尺寸 in.	基本订购号	尺寸					
			A	D	E	F	面板孔尺寸	最大面板厚度
英制尺寸, mm								
1/16	1/16	-7-1-1NT	30.2	8.6	1.3	7.9	5.2	6.4
	1/8	-7-1-2NT	32.3	8.6	1.3	11.1	5.2	6.4
1/8	1/8	-7-2-2NT	46.5	12.7	2.3	12.7	8.3	12.7
3/16	1/8	-7-3-2NT	48.0	13.7	3.0	14.3	9.9	12.7
1/4	1/8	-7-4-2NT	49.5	15.2	4.8	15.9	11.5	10.2
	1/4	-7-4-4NT	54.1	15.2	4.8	15.9	11.5	10.2
	3/8	-7-4-6NT	54.9	15.2	4.8	17.5	11.5	10.2
	1/2	-7-4-8NT	60.3	15.2	4.8	22.2	11.5	10.2
5/16	1/8	-7-5-2NT	52.8	16.3	4.8	17.5	13.1	11.2
	1/4	-7-5-4NT	57.7	16.3	6.4	17.5	13.1	11.2
3/8	1/8	-7-6-2NT	52.9	16.8	4.8	19.1	14.7	11.2
	1/4	-7-6-4NT	57.4	16.8	7.1	19.1	14.7	11.2
	3/8	-7-6-6NT	57.4	16.8	7.1	19.1	14.7	11.2
	1/2	-7-6-8NT	63.8	16.8	7.1	22.2	14.7	11.2
1/2	1/8	-7-8-2NT	58.7	22.9	4.8	23.8	19.4	12.7
	1/4	-7-8-4NT	63.2	22.9	7.1	23.8	19.4	12.7
	3/8	-7-8-6NT	63.2	22.9	9.7	23.8	19.4	12.7
	1/2	-7-8-8NT	68.8	22.9	10.4	23.8	19.4	12.7
5/8	3/8	-7-10-6NT	66.7	24.4	9.7	27.0	22.6	15.1
	1/2	-7-10-8NT	71.5	24.4	11.9	27.0	22.6	15.1
3/4	1/2	-7-12-8NT	76.2	24.4	11.9	30.2	25.8	16.8
	3/4	-7-12-12NT	76.2	24.4	15.7	30.2	25.8	16.8
7/8	3/4	-7-14-12NT	84.1	25.9	15.7	33.3	29.0	19.1
1	3/4	-7-16-12NT	88.4	31.2	15.7	41.3	33.7	19.1
	1	-7-16-16NT	93.2	31.2	22.4	41.3	33.7	19.1
公制尺寸, mm								
6	1/8	-7-6M-2NT	49.6	15.3	4.8	16	11.5	10.2
	1/4	-7-6M-4NT	53.6	15.3	4.8	16	11.5	10.2
8	1/8	-7-8M-2NT	52.3	16.2	4.8	18	13.1	11.2
	1/4	-7-8M-4NT	57.5	16.2	6.4	18	13.1	11.2
10	1/4	-7-10M-4NT	58.4	17.2	7.9	22	16.3	11.2
	3/8	-7-10M-6NT	58.4	17.2	7.9	22	16.3	11.2
	1/2	-7-10M-8NT	63.1	17.2	7.9	22	16.3	11.2
12	1/4	-7-12M-4NT	63.9	22.8	7.9	24	19.5	12.7
	3/8	-7-12M-6NT	63.9	22.8	9.5	24	19.5	12.7
	1/2	-7-12M-8NT	68.8	22.8	9.5	24	19.5	12.7

卡套接头

VCR接头

焊接接头

通用阀门

高纯阀门

卡套管

技术信息

# ISO/BSP 锥形RT外螺纹 (英制)

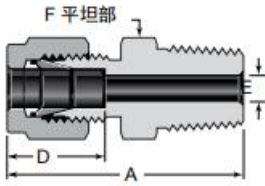

卡套管 外径	ISO 螺纹尺寸	基本订购号	尺寸			
			A	D	E	F
英制尺寸, mm						
1/8	1/8	-2-2-2RT	30.5	12.7	2.3	11.1
	1/4	-2-2-4RT	35.6	12.7	2.3	14.3
1/4	1/8	-2-4-2RT	32.8	15.2	4.8	12.7
	1/4	-2-4-4RT	37.8	15.2	4.8	14.3
	3/8	-2-4-6RT	38.4	15.2	4.8	17.5
	1/2	-2-4-8RT	44.7	15.2	4.8	22.2
5/16	1/8	-2-5-2RT	34.0	16.3	4.8	14.3
	1/4	-2-5-4RT	38.6	16.3	6.4	14.3
3/8	1/8	-2-6-2RT	35.3	16.8	4.8	15.9
	1/4	-2-6-4RT	39.9	16.8	7.1	15.9
	3/8	-2-6-6RT	39.9	16.8	7.1	17.5
	1/2	-2-6-8RT	46.2	16.8	7.1	22.2
	3/4	-2-6-12RT	47.8	16.8	7.1	27.0
1/2	1/4	-2-8-4RT	43.4	22.9	7.1	20.6
	3/8	-2-8-6RT	43.4	22.9	9.7	20.6
	1/2	-2-8-8RT	49.0	22.9	10.4	22.2
	3/4	-2-8-12RT	50.5	22.9	10.4	27.0
5/8	1/2	-2-10-8RT	49.0	24.4	11.9	23.8
3/4	3/4	-2-12-12RT	50.5	24.4	15.7	27.0
	1	-2-12-16RT	57.2	24.4	15.7	34.9
1	3/4	-2-16-12RT	57.4	31.2	15.7	34.9
	1	-2-16-16RT	62.2	31.2	22.4	34.9

卡套接头

VCR接头

焊接接头

通用阀门

高纯阀门

卡套管

技术信息

## ISO/BSP 锥形RT外螺纹 (公制)

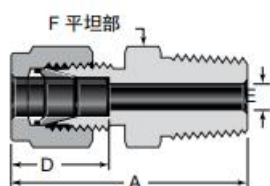

卡套管 外径	ISO螺纹 尺寸 in.	基本订购号	尺寸			
			A	D	E	F
公制尺寸, mm						
2	1/8	-2-2M-2RT	30.5	12.9	1.7	12
3	1/8	-2-3M-2RT	30.5	12.9	2.4	12
	1/4	-2-3M-4RT	35.6	12.9	2.4	14
4	1/8	-2-4M-2RT	31.2	13.7	2.4	12
	1/4	-2-4M-4RT	36.3	13.7	2.4	14
6	1/8	-2-6M-2RT	32.8	15.3	4.8	14
	1/4	-2-6M-4RT	37.9	15.3	4.8	14
	3/8	-2-6M-6RT	38.4	15.3	4.8	18
	1/2	-2-6M-8RT	44.7	15.3	4.8	22
8	1/8	-2-8M-2RT	34.2	16.2	4.8	15
	1/4	-2-8M-4RT	38.7	16.2	6.4	15
	3/8	-2-8M-6RT	39.2	16.2	6.4	18
	1/2	-2-8M-8RT	45.6	16.2	6.4	22
10	1/8	-2-10M-2RT	36.3	17.2	4.8	18
	1/4	-2-10M-4RT	40.9	17.2	7.1	18
	3/8	-2-10M-6RT	40.9	17.2	7.9	18
	1/2	-2-10M-8RT	46.5	17.2	7.9	22
	3/4	-2-10M-12RT	48.0	17.2	7.9	27
12	1/8	-2-12M-2RT	38.3	22.8	4.8	22
	1/4	-2-12M-4RT	43.4	22.8	7.1	22
	3/8	-2-12M-6RT	43.4	22.8	9.5	22
	1/2	-2-12M-8RT	49.0	22.8	9.5	22
	3/4	-2-12M-12RT	50.5	22.8	9.5	27
14	1/8	-2-14M-2RT	38.8	24.4	4.8	24
	1/4	-2-14M-4RT	44.1	24.4	7.1	24
	3/8	-2-14M-6RT	44.1	24.4	7.9	24
	1/2	-2-14M-8RT	49.0	24.4	11.1	24
	3/4	-2-14M-12RT	50.5	24.4	11.1	27
15	1/2	-2-15M-8NT	49.0	24.4	11.9	24
16	1/4	-2-16M-4RT	44.1	24.4	7.1	24
	3/8	-2-16M-6RT	44.1	24.4	9.5	24
	1/2	-2-16M-8RT	49.0	24.4	11.9	24
	3/4	-2-16M-12RT	50.5	24.4	12.7	27
18	1/2	-2-18M-8RT	50.5	24.4	11.9	27
	3/4	-2-18M-12RT	50.5	24.4	15.1	27
20	1/2	-2-20M-8RT	52.3	26.0	11.9	30
	3/4	-2-20M-12RT	52.3	26.0	15.9	30
22	3/4	-2-22M-12RT	52.3	26.0	15.9	30
	1	-2-22M-16RT	57.1	26.0	18.3	35
25	1/2	-2-25M-8RT	57.5	31.3	11.9	35
	3/4	-2-25M-12RT	57.5	31.3	15.9	35
	1	-2-25M-16RT	62.3	31.3	21.8	35
28	1	-2-28M-16RT	72.4	36.6	21.8	41
	1 1/4	-2-28M-20RT	73.1	36.6	21.8	46
30	1 1/4	-2-30M-20RT	77.2	39.6	26.2	46
32	1 1/4	-2-32M-20RT	79.6	42.0	28.6	46
38	1 1/2	-2-38M-24RT	91.6	49.4	33.7	55

## ISO/BSP 平行RS外螺纹接头 (公制)

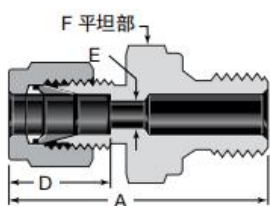

卡套管 外径	ISO螺纹 尺寸in.	基本订购号	尺寸			
			A	D	E	F
公制尺寸, mm						
2	1/8	-2-2M-2RS	30.0	12.9	1.7	14
3	1/8	-2-3M-2RS	30.0	12.9	2.4	14
	1/4	-2-3M-4RS	35.3	12.9	2.4	19
4	1/8	-2-4M-2RS	30.7	13.7	2.4	14
	1/4	-2-4M-4RS	36.0	13.7	2.4	19
6	1/8	-2-6M-2RS	32.3	15.3	4.0	14
	1/4	-2-6M-4RS	37.6	15.3	4.8	19
	3/8	-2-6M-6RS	38.9	15.3	4.8	22
	1/2	-2-6M-8RS	44.7	15.3	4.8	27
8	1/8	-2-8M-2RS	33.2	16.2	4.0	15
	1/4	-2-8M-4RS	38.5	16.2	6.4	19
	3/8	-2-8M-6RS	39.8	16.2	6.4	22
	1/2	-2-8M-8RS	45.6	16.2	6.4	27
10	3/4	-2-8M-12RS	49.5	16.2	6.4	35
	1/4	-2-10M-4RS	39.4	17.2	5.9	19
	3/8	-2-10M-6RS	40.6	17.2	7.9	22
	1/2	-2-10M-8RS	46.5	17.2	7.9	27
12	1/4	-2-12M-4RS	42.6	22.8	5.9	22
	3/8	-2-12M-6RS	43.1	22.8	7.9	22
	1/2	-2-12M-8RS	49.0	22.8	9.5	27
	3/4	-2-12M-12RS	52.8	22.8	9.5	35
14	1/4	-2-14M-4RS	42.9	24.4	7.1	24
	3/8	-2-14M-6RS	43.9	24.4	7.9	24
	1/2	-2-14M-8RS	49.0	24.4	11.1	27
	3/4	-2-14M-12RS	52.8	24.4	11.1	35
15	3/8	-2-15M-6RS	43.9	24.4	7.9	24
	1/2	-2-15M-8RS	49.0	24.4	11.9	27
	3/4	-2-15M-12RS	52.8	24.4	11.9	35
16	3/8	-2-16M-6RS	43.9	24.4	7.9	24
	1/2	-2-16M-8RS	49.0	24.4	11.9	27
	3/4	-2-16M-12RS	52.8	24.4	12.7	35
18	1/2	-2-18M-8RS	49.0	24.4	11.9	27
	3/4	-2-18M-12RS	52.8	24.4	15.1	35
20	1/2	-2-20M-8RS	50.5	26.0	11.9	30
	3/4	-2-20M-12RS	52.8	26.0	15.9	35
22	3/4	-2-22M-12RS	52.8	26.0	15.9	35
	1	-2-22M-16RS	55.3	26.0	18.3	41
25	3/4	-2-25M-12RS	57.5	31.3	15.9	35
	1	-2-25M-16RS	60.1	31.3	19.8	41
28	1	-2-28M-16RS	70.1	36.6	19.8	41
	1 1/4	-2-28M-20RS	73.9	36.6	21.8	50
30	1 1/4	-2-30M-20RS	76.5	39.6	25.0	50
32	1 1/4	-2-32M-20RS	78.9	42.0	25.0	50
38	1 1/2	-2-38M-24RS	90.8	49.4	31.8	55

卡套接头

VCR接头

焊接接头

通用阀门

高纯阀门

卡套管

技术信息

## ISO/BSP 平行RS外螺纹接头 (英制)

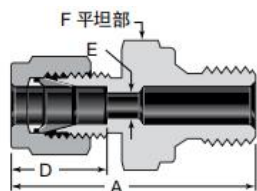

卡套管 外径	ISO螺纹 尺寸	基本订购号	尺寸			
			A	D	E	F
英制尺寸, mm						
1/8	1/8	-2-2-2RS	30.0	12.7	2.3	14.3
	1/4	-2-2-4RS	35.3	12.7	2.3	19.1
	3/8	-2-2-6RS	36.3	12.7	2.3	22.2
1/4	1/8	-2-4-2RS	32.3	15.2	4.0	14.3
	1/4	-2-4-4RS	37.6	15.2	4.8	19.1
	3/8	-2-4-6RS	38.9	15.2	4.8	22.2
	1/2	-2-4-8RS	44.7	15.2	4.8	27.0
3/8	1/8	-2-6-2RS	37.8	16.8	4.0	15.9
	1/4	-2-6-4RS	39.1	16.8	5.9	19.1
	3/8	-2-6-6RS	40.4	16.8	7.1	22.2
	1/2	-2-6-8RS	46.2	16.8	7.1	27.0
1/2	1/4	-2-8-4RS	42.7	22.9	5.9	20.6
	3/8	-2-8-6RS	43.2	22.9	7.9	22.2
	1/2	-2-8-8RS	49.0	22.9	10.4	27.0
3/4	1/2	-2-12-8RS	49.0	24.4	11.9	27.0
	3/4	-2-12-12RS	52.9	24.4	15.7	33.3
1	1/2	-2-16-8RS	55.5	31.2	11.9	34.9
	3/4	-2-16-12RS	57.7	31.2	16.0	34.9
	1	-2-16-16RS	59.9	31.2	19.8	41.3

## ISO/BSP 平行垫片

铜制 (RP和RS接头)

RS/RSD  
垫片RSNB  
垫片

ISO螺纹尺 寸in.	基本订购号		
	RS 垫片	RSD 垫片	RSNB 垫片
1/8	S-RS-2	SS-RSD-2	4L-RSNB-2
1/4	S-RS-4	SS-RSD-4	4L-RSNB-4
3/8	S-RS-6	SS-RSD-6	4L-RSNB-6
1/2	S-RS-8	SS-RSD-8	4L-RSNB-8
3/4	S-RS-12	SS-RSD-12	4L-RSNB-12
1	S-RS-16	SS-RSD-16	4L-RSNB-16
1 1/4	S-RS-20	SS-RSD-20	4L-RSNB-20
1 1/2	S-RS-24	SS-RSD-24	4L-RSNB-24

# ISO/BSP 平行RP外螺纹接头

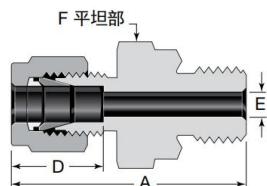

卡套管 外径	ISO螺纹 尺寸 in.	基本订购号	尺寸			
			A	D	E	F
公制尺寸, mm						
3	1/8	-2-3M-2RP	30.0	12.9	2.4	14
	1/4	-2-3M-4RP	35.3	12.9	2.4	19
4	1/8	-2-4M-2RP	30.7	13.7	2.4	14
6	1/8	-2-6M-2RP	32.3	15.3	4.0	14
	1/4	-2-6M-4RP	37.6	15.3	4.8	19
	3/8	-2-6M-6RP	38.9	15.3	4.8	22
8	1/2	-2-6M-8RP	44.7	15.3	4.8	27
	1/8	-2-8M-2RP	33.3	16.2	4.0	15
	1/4	-2-8M-4RP	38.5	16.2	5.9	19
	3/8	-2-8M-6RP	39.8	16.2	6.4	22
10	1/2	-2-8M-8RP	45.6	16.2	6.4	27
	1/4	-2-10M-4RP	39.4	17.2	5.9	19
	3/8	-2-10M-6RP	40.6	17.2	7.9	22
12	1/2	-2-10M-8RP	46.5	17.2	7.9	27
	1/4	-2-12M-4RP	42.6	22.8	5.9	22
	3/8	-2-12M-6RP	43.1	22.8	7.9	22
	1/2	-2-12M-8RP	49.0	22.8	9.5	27
15	3/4	-2-12M-12RP	52.8	22.8	9.5	35
	1/2	-2-15M-8RP	49.0	24.4	11.9	27
	3/8	-2-16M-6RP	43.9	24.4	7.9	24
16	1/2	-2-16M-8RP	49.0	24.4	11.9	27
	1/2	-2-18M-8RP	49.0	24.4	11.9	27
18	3/4	-2-18M-12RP	52.8	24.4	15.1	35
	1/2	-2-20M-8RP	50.5	26.0	11.9	30
20	3/4	-2-20M-12RP	52.8	26.0	15.9	35
	3/4	-2-22M-12RP	52.8	26.0	15.9	35
22	1	-2-22M-16RP	55.3	26.0	18.3	41
	3/4	-2-25M-12RP	57.5	31.3	15.9	35
25	1	-2-25M-16RP	60.1	31.3	19.8	41
	1	-2-28M-16RP	70.1	36.6	19.8	41
28	1 1/4	-2-28M-20RP	73.9	36.6	21.8	50
	1 1/4	-2-30M-20RP	76.5	39.6	26.2	50
30	1 1/4	-2-32M-20RP	78.9	42.0	28.6	50
32	1 1/4	-2-32M-20RP	78.9	42.0	28.6	50
38	1 1/2	-2-38M-24RP	89.3	49.4	31.8	55
英制尺寸, mm						
1/8	1/8	-2-2-2RP	30.0	12.7	2.3	14.3
	1/4	-2-2-4RP	35.3	12.7	2.3	19.1
1/4	1/8	-2-4-2RP	32.3	15.2	4.1	14.3
	1/4	-2-4-4RP	37.6	15.2	4.8	19.1
1/2	3/8	-2-8-6RP	40.4	22.9	7.9	22.2
	1/2	-2-8-8RP	49.0	22.9	10.4	27.0
3/4	1/2	-2-12-8RP	49.0	24.4	11.9	27.0
	3/4	-2-12-12RP	52.9	24.4	15.7	33.3
1	1	-2-16-16RP	59.9	31.2	19.8	41.3

## ISO/BSP 平行垫片 铜制 (RP和RS接头)



ISO螺纹 尺寸in.	基本 订购号
1/8	CU-RP-2
1/4	CU-RP-4
3/8	CU-RP-6
1/2	CU-RP-8
3/4	CU-RP-12
1	CU-RP-16
1 1/4	CU-RP-20
1 1/2	CU-RP-24

卡套接头

VCR接头

焊接接头

通用阀门

高纯阀门

卡套管

技术信息

## SAE/MS ST直螺纹接头

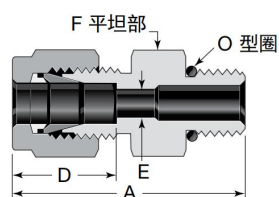

卡套管 外径	SAE/MS 螺纹尺寸	基本订购号	尺寸			
			A	D	E	F
英制尺寸, mm						
1/16	5/16-24	-2-1-2ST	23.4	8.6	1.3	11.1
1/8	5/16-24	-2-2-2ST	30.0	12.7	2.3	11.1
	7/16-20	-2-2-4ST	31.5	12.7	2.3	14.3
	9/16-18	-2-2-6ST	33.3	12.7	2.3	17.5
3/16	3/8-24	-2-3-3ST	30.5	13.7	3.0	12.7
1/4	5/16-24	-2-4-2ST	32.3	15.2	2.3	12.7
	7/16-20	-2-4-4ST	34.0	15.2	4.8	14.3
	9/16-18	-2-4-6ST	35.6	15.2	4.8	17.5
	3/4-16	-2-4-8ST	37.6	15.2	4.8	22.2
	7/8-14	-2-4-10ST	40.6	15.2	4.8	25.4
5/16	1/2-20	-2-5-5ST	34.8	16.3	6.4	15.9
3/8	7/16-20	-2-6-4ST	35.6	16.8	5.1	15.9
	9/16-18	-2-6-6ST	37.1	16.8	7.1	17.5
	3/4-16	-2-6-8ST	39.1	16.8	7.1	22.2
	7/8-14	-2-6-10ST	42.2	22.9	7.1	25.4
1/2	9/16-18	-2-8-6ST	39.1	22.9	7.1	20.6
	3/4-16	-2-8-8ST	41.9	22.9	10.4	22.2
	7/8-14	-2-8-10ST	45.0	22.9	10.4	25.4
	1 1/16-12	-2-8-12ST	49.0	22.9	10.4	31.8
5/8	3/4-16	-2-10-8ST	41.9	24.4	10.7	23.8
	7/8-14	-2-10-10ST	45.2	24.4	12.7	25.4
3/4	3/4-16	-2-12-8ST	46.0	24.4	10.7	27.0
	1 1/16-12	-2-12-12ST	49.0	24.4	15.7	31.8
	1 5/16-12	-2-12-16ST	49.8	24.4	16.0	38.1
7/8	1 3/16-12	-2-14-14ST	49.0	25.9	18.3	34.9
1	1 1/16-12	-2-16-12ST	53.3	31.2	16.8	34.9
	1 5/16-12	-2-16-16ST	54.4	31.2	22.4	38.1
1 1/4	1 5/8-12	-2-16-20ST	68.3	41.1	27.7	47.6
1 1/2	1 7/8-12	-2-16-24ST	77.7	50.0	34.0	54.0
公制尺寸, mm						
6	9/16-18	-2-6M-6ST	35.6	35.6	35.6	18
10	9/16-18	-2-10M-6ST	37.3	37.3	37.3	22
	3/4-16	-2-10M-8ST	39.4	39.4	39.4	22
12	7/16-20	-2-12M-4ST	40.6	40.6	40.6	22
	9/16-18	-2-12M-6ST	39.9	39.9	39.9	22

卡套接头

VCR接头

焊接接头

通用阀门

高纯阀门

卡套管

技术信息

### AN外螺纹接头

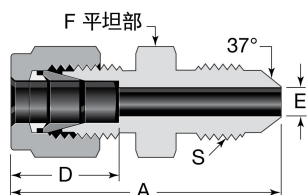

卡套管 外径	AN卡套管 扩口尺寸	基本订购号	尺寸			
			A	D	E	F
尺寸, in.(mm)						
1/16	1/8	-2-1-2AN	1.07(27.2)	0.34(8.6)	0.05(1.3)	0.44(11.1)
1/8	1/8	-2-2-2AN	1.27(32.3)	0.50(12.7)	0.06(1.5)	0.44(11.1)
	1/4	-2-2-4AN	1.38(35.1)	0.50(12.7)	0.09(2.3)	0.50(12.7)
3/16	3/16	-2-3-3AN	1.32(33.5)	0.54(13.7)	0.09(2.3)	0.44(11.1)
1/4	1/4	-2-4-4AN	1.48(37.6)	0.60(15.2)	0.17(4.3)	0.50(12.7)
5/16	5/16	-2-5-5AN	1.51(38.4)	0.64(16.2)	0.23(5.8)	0.56(14.3)
3/8	1/4	-2-6-4AN	1.56(39.6)	0.66(16.8)	0.17(4.3)	0.63(15.9)
	3/8	-2-6-6AN	1.56(39.6)	0.66(16.8)	0.28(7.1)	0.63(15.9)
1/2	1/2	-2-8-8AN	1.81(46.0)	0.90(22.8)	0.39(9.9)	0.81(20.6)
5/8	5/8	-2-10-10AN	1.93(49.0)	0.96(24.5)	0.48(12.3)	0.94(23.8)
3/4	3/4	-2-12-12AN	2.10(53.3)	0.96(24.4)	0.61(15.5)	1.13(28.6)
1	1	-2-16-16AN	2.42(61.5)	1.23(31.2)	0.84(21.3)	1.37(34.9)

### AN外螺纹穿板接头

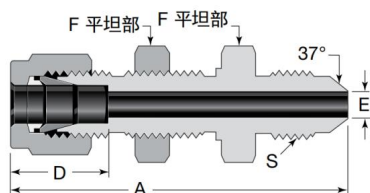

卡套管 外径	AN卡套管 扩口尺寸	基本订购号	尺寸					
			A	D	E	F	面板孔尺寸	最大面板厚度
尺寸, in.(mm)								
1/8	1/8	-7-2-2AN	1.91 (48.5)	0.50 (12.7)	0.06 (1.5)	0.50 (12.7)	0.33 (8.3)	0.50 (12.7)
	1/4	-7-2-4AN	2.04 (51.8)	0.50 (12.7)	0.09 (2.3)	0.63 (15.9)	0.33 (8.3)	0.51 (12.7)
3/16	3/16	-7-3-3AN	1.98 (50.3)	0.54 (13.7)	0.09 (2.3)	0.56 (14.3)	0.39 (9.9)	0.50 (12.7)
1/4	1/4	-7-4-4AN	2.12 (53.8)	0.60 (15.2)	0.17 (4.3)	0.63 (15.9)	0.45 (11.5)	0.40 (10.2)
5/16	5/16	-7-5-5AN	2.21 (56.1)	0.64 (16.2)	0.23 (5.8)	0.69 (17.5)	0.52 (13.1)	0.56 (14.3)
3/8	1/4	-7-6-4AN	2.25 (57.2)	0.66 (16.8)	0.17 (4.3)	0.75 (19.1)	0.58 (14.7)	0.44 (11.2)
	3/8	-7-6-6AN	2.25 (57.2)	0.66 (16.8)	0.28 (7.1)	0.75 (19.1)	0.58 (14.7)	0.44 (11.2)
1/2	1/2	-7-8-8AN	2.59 (65.8)	0.90 (22.8)	0.39 (9.9)	0.94 (23.8)	0.76 (19.4)	0.50 (12.7)
5/8	5/8	-7-10-10AN	2.74 (69.6)	0.96 (24.4)	0.48 (12.3)	1.06 (27.0)	0.89 (22.6)	0.59 (15.1)
3/4	3/4	-7-12-12AN	3.11 (79.0)	0.96 (24.4)	0.61 (15.5)	1.19 (30.2)	1.02 (25.8)	0.66 (16.8)
1	1	-7-16-16AN	3.64 (92.5)	1.23 (31.2)	0.84 (21.3)	1.63 (41.3)	1.33 (33.7)	0.75 (19.1)

## O型圈密封 (SAE/MS 直螺纹)

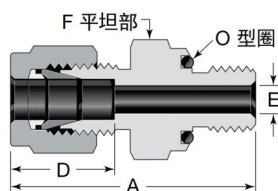

卡套管 外径	SAE/MS 螺纹尺寸	基本订购号	尺寸			
			A	D	E	F
尺寸, mm						
1/16	5/16-24	-2-1-2STO	26.7	8.6	1.3	14.3
1/8	5/16-24	-2-2-2STO	32.8	12.7	2.3	14.3
3/16	3/8-24	-2-3-3STO	34.3	13.7	3.0	15.9
1/4	7/16-20	-2-4-4STO	38.4	15.2	4.8	19.1
5/16	1/2-20	-2-5-5STO	40.6	16.3	6.4	22.2
3/8	9/16-18	-2-6-6STO	42.4	16.8	7.1	23.8
1/2	3/4-16	-2-8-8STO	46.0	22.9	10.4	28.6
3/4	1 1/16-12	-2-12-12STO	52.3	24.4	15.7	38.1
1	1 5/16-12	-2-16-16STO	58.2	31.2	22.4	44.5

## O圈密封NPT接头

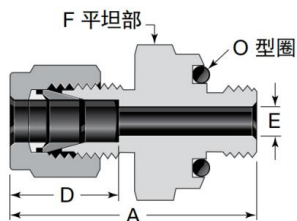

卡套管 外径	NPT 尺寸	基本订购号	尺寸			
			A	D	E	F
尺寸, mm						
1/8	1/8	-2-2-2NTO	32.8	8.6	2.3	19.1
1/4	1/8	-2-4-2NTO	35.1	15.2	4.8	19.1
	1/4	-2-4-4NTO	38.4	15.2	4.8	23.8
3/8	1/4	-2-6-4NTO	39.9	16.8	7.1	23.8
	3/8	-2-6-6NTO	41.4	16.8	7.1	28.6
	1/2	-2-6-8NTO	47.0	16.8	7.1	33.3
1/2	1/2	-2-8-8NTO	49.8	22.9	10.4	33.3

## 卡套管承插焊

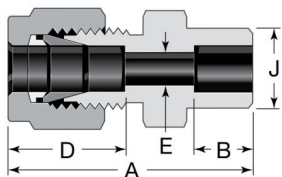

卡套管 外径	承插焊 尺寸	基本 订购号	尺寸				
			A	B	D	E	J
尺寸, mm							
1/8	1/8	-2-2-2TW	29.0	8.6	12.7	2.3	7.9
3/16	3/16	-2-3-3TW	29.7	9.5	13.7	3.3	10.7
1/4	1/4	-2-4-4TW	33.5	10.4	15.2	4.8	11.2
3/8	3/8	-2-6-6TW	37.6	11.9	16.8	7.1	15.7
1/2	1/2	-2-8-8TW	41.1	11.9	22.9	10.4	19.1
5/8	5/8	-2-10-10TW	41.9	11.9	24.4	12.7	23.4
3/4	3/4	-2-12-12TW	43.4	11.9	24.4	15.7	26.7
1	1	-2-16-16TW	52.6	14.2	31.2	22.4	33.3

## 公称管外焊 (英制)

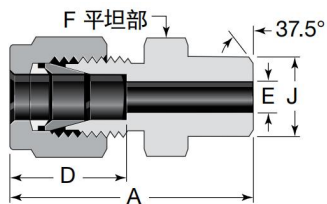

卡套管 外径	公称管焊接 尺寸	基本 订购号	尺寸				
			A	D	E	F	J
尺寸, in.							
1/8	1/8	-2-2-2PW	30.5	12.7	2.3	11.1	10.3
3/16	1/8	-2-3-2PW	31.2	13.7	3.0	11.1	10.3
1/4	1/8	-2-4-2PW	32.8	15.2	4.8	12.7	10.3
	1/4	-2-4-4PW	37.8	15.2	4.8	14.3	13.7
5/16	1/8	-2-5-2PW	34.0	16.3	5.3	14.3	10.3
	1/4	-2-5-4PW	38.6	16.3	6.4	14.3	13.7
3/8	1/4	-2-6-4PW	39.9	16.8	7.1	15.9	13.7
	3/8	-2-6-6PW	39.9	16.8	7.1	17.5	17.1
	1/2	-2-6-8PW	46.2	16.8	7.1	22.2	21.3
	3/4	-2-6-12PW	47.8	16.8	7.1	27.0	26.7
1/2	3/8	-2-8-6PW	43.4	22.9	10.4	20.6	17.1
	1/2	-2-8-8PW	49.0	22.9	10.4	22.2	21.3
	3/4	-2-8-12PW	50.5	22.9	10.4	27.0	26.7
5/8	1/2	-2-10-8PW	49.0	24.4	12.7	23.8	21.3
3/4	1/2	-2-12-8PW	50.5	24.4	14.0	27.0	21.3
	3/4	-2-12-12PW	50.5	24.4	15.7	27.0	26.7
1	1	-2-16-16PW	62.2	31.2	22.4	34.9	33.4
1 1/4	1 1/4	-2-20-20PW	77.2	41.1	27.7	44.5	42.2
1 1/2	1 1/2	-2-24-24PW	88.9	50.0	34.0	54.0	48.3

## 公称管外焊 (公制到英制)

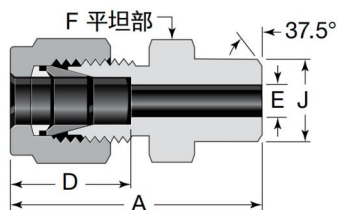

卡套管 外径	公称管 焊接 尺寸in.	基本 订购号	尺寸			
			A	D	E	F
尺寸, mm						
3	1/8	-2-3M-2PW	30.5	12.9	2.4	12
4	1/8	-2-4M-2PW	31.5	13.7	2.4	12
6	1/8	-2-6M-2PW	32.8	15.3	4.8	14
	1/4	-2-6M-4PW	37.9	15.3	4.8	14
8	1/8	-2-8M-2PW	34.2	16.2	5.4	15
	1/4	-2-8M-4PW	38.7	16.2	6.4	15
	1/2	-2-8M-8PW	45.6	16.2	6.4	22
10	1/4	-2-10M-4PW	40.9	17.2	7.5	18
	3/8	-2-10M-6PW	40.9	17.2	7.9	18
	1/2	-2-10M-8PW	46.5	17.2	7.9	22
12	1/4	-2-12M-4PW	43.4	22.8	7.5	22
	3/8	-2-12M-6PW	43.4	22.8	9.5	22
	1/2	-2-12M-8PW	49.0	22.8	9.5	22
14	3/8	-2-14M-6PW	44.1	24.4	10.7	24
15	1/2	-2-15M-8PW	49.0	24.4	11.9	24
16	1/2	-2-16M-8PW	49.0	24.4	12.7	24
18	1/2	-2-18M-8PW	50.5	24.4	13.9	27
30	1 1/4	-2-30M-20PW	77.2	39.6	26.2	46
32	1 1/4	-2-32M-20PW	79.6	42.0	28.6	46
38	1 1/2	-2-38M-24PW	91.6	49.4	33.7	55

卡套接头

VCR接头

焊接接头

通用阀门

高纯阀门

卡套管

技术信息

## NPT内螺纹连接 (英制)

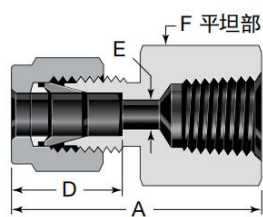

卡套管 外径	NPT 尺寸	基本 订购号	尺寸			
			A	D	E	F
尺寸, mm						
1/16	1/16	-2-1-1FNT	23.6	8.6	1.3	11.1
	1/8	-2-1-2FNT	24.4	8.6	1.3	14.3
1/8	1/8	-2-2-2FNT	28.7	12.7	2.3	14.3
	1/4	-2-2-4FNT	33.5	12.7	2.3	19.1
3/16	1/8	-2-3-2FNT	29.7	13.7	3.0	14.3
1/4	1/8	-2-4-2FNT	31.2	15.2	4.8	14.3
	1/4	-2-4-4FNT	35.8	15.2	4.8	19.1
	3/8	-2-4-6FNT	37.6	15.2	4.8	22.2
	1/2	-2-4-8FNT	42.4	15.2	4.8	27.0
5/16	1/8	-2-5-2FNT	32.0	16.3	6.4	14.3
	1/4	-2-5-4FNT	36.8	16.3	6.4	19.1
3/8	1/8	-2-6-2FNT	32.8	16.8	7.1	15.9
	1/4	-2-6-4FNT	37.6	16.8	7.1	19.1
	3/8	-2-6-6FNT	39.1	16.8	7.1	22.2
	1/2	-2-6-8FNT	43.9	16.8	7.1	27.0
	3/4	-2-6-12FNT	47.8	16.8	7.1	33.3
1/2	1/4	-2-8-4FNT	40.4	22.9	10.4	20.6
	3/8	-2-8-6FNT	41.9	22.9	10.4	22.2
	1/2	-2-8-8FNT	46.7	22.9	10.4	27.0
	3/4	-2-8-12FNT	48.3	22.9	10.4	33.3
5/8	3/8	-2-10-6FNT	41.9	24.4	12.7	23.8
	1/2	-2-10-8FNT	46.7	24.4	12.7	27.0
3/4	1/2	-2-12-8FNT	46.7	24.4	15.7	27.0
	3/4	-2-12-12FNT	48.3	24.4	15.7	33.3
7/8	3/4	-2-14-12FNT	49.8	25.9	18.3	33.3
	1	-2-16-12FNT	53.3	31.2	22.4	34.9
1	3/4	-2-16-12FNT	53.3	31.2	22.4	34.9
	1	-2-16-16FNT	62.2	31.2	22.4	41.3
1 1/4	1 1/4	-2-20-20FNT	74.7	41.1	27.7	54.0
1 1/2	1 1/2	-2-24-24FNT	83.3	50.0	36.3	60.3

卡套接头

VCR接头

焊接接头

通用阀门

高纯阀门

卡套管

技术信息

## NPT内螺纹连接 (公制)

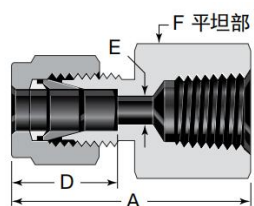

卡套管 外径	NPT 尺寸 in.	基本 订购号	尺寸			
			A	D	E	F
尺寸, mm						
3	1/8	-2-3M-2FNT	28.7	12.9	2.4	14
	1/4	-2-3M-4FNT	33.5	12.9	2.4	19
4	1/8	-2-4M-2FNT	29.7	13.7	2.4	14
6	1/8	-2-6M-2FNT	31.3	15.3	4.8	14
	1/4	-2-6M-4FNT	35.8	15.3	4.8	19
	3/8	-2-6M-6FNT	37.7	15.3	4.8	22
	1/2	-2-6M-8FNT	42.5	15.3	4.8	27
8	1/8	-2-8M-2FNT	32.1	16.2	6.4	15
	1/4	-2-8M-4FNT	37.0	16.2	6.4	19
	3/8	-2-8M-6FNT	38.5	16.2	6.4	22
	1/2	-2-8M-8FNT	43.3	16.2	6.4	27
10	1/8	-2-10M-2FNT	33.0	17.2	6.4	18
	1/4	-2-10M-4FNT	37.8	17.2	7.9	19
	3/8	-2-10M-6FNT	39.4	17.2	7.9	22
	1/2	-2-10M-8FNT	44.2	17.2	7.9	27
12	1/4	-2-12M-4FNT	40.3	22.8	7.9	22
	3/8	-2-12M-6FNT	41.9	22.8	9.5	22
	1/2	-2-12M-8FNT	46.7	22.8	9.5	27
	3/4	-2-12M-12FNT	49.7	22.8	9.5	35
14	3/4	-2-14M-12FNT	49.7	24.4	11.1	35
15	1/2	-2-15M-8FNT	46.7	24.4	11.9	27
16	3/8	-2-16M-6FNT	41.9	24.4	9.5	27
	1/2	-2-16M-8FNT	46.9	24.4	11.9	27
20	1/2	-2-20M-8FNT	47.9	26.0	11.9	30
	3/4	-2-20M-12FNT	49.7	26.0	15.9	35
22	3/4	-2-22M-12FNT	49.7	26.0	15.9	35
	1	-2-22M-16FNT	57.9	26.0	18.3	41
25	3/4	-2-25M-12FNT	53.4	31.3	15.9	35
	1	-2-25M-16FNT	62.3	31.3	21.8	41

卡套接头

VCR接头

焊接接头

通用阀门

高纯阀门

卡套管

技术信息

## ISO/BSP 锥形内螺纹 (RT)

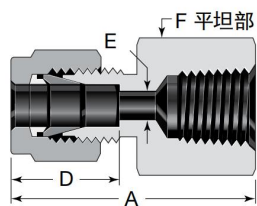

卡套管 外径	ISO螺纹 尺寸in.	基本 订购号	尺寸			
			A	D	E	F
英制尺寸, mm						
1/4	1/8	-2-4-2FRT	31.2	15.2	4.8	14.3
	1/4	-2-4-4FRT	35.8	15.2	4.8	19.1
	3/8	-2-4-6FRT	37.6	15.2	4.8	22.2
	1/2	-2-4-8FRT	42.4	15.2	4.8	27.0
3/8	1/4	-2-6-4FRT	37.6	16.8	7.1	19.1
	3/8	-2-6-6FRT	39.1	16.8	7.1	22.2
	1/2	-2-6-8FRT	43.9	16.8	7.1	27.0
1/2	1/4	-2-8-4FRT	40.4	22.9	10.4	20.6
	3/8	-2-8-6FRT	41.9	22.9	10.4	22.2
	1/2	-2-8-8FRT	46.7	22.9	10.4	27.0
公制尺寸, mm						
3	1/8	-2-3M-2FRT	28.7	12.9	2.4	14
6	1/8	-2-6M-2FRT	31.3	15.3	4.8	14
	1/4	-2-6M-4FRT	35.8	15.3	4.8	19
	3/8	-2-6M-6FRT	36.9	15.3	4.8	22
	1/2	-2-6M-8FRT	42.5	15.3	4.8	27
8	1/8	-2-8M-2FRT	32.1	16.2	6.4	15
	1/4	-2-8M-4FRT	37.0	16.2	6.4	19
	3/8	-2-8M-6FRT	38.5	16.2	6.4	22
	1/2	-2-8M-8FRT	43.3	16.2	6.4	27
10	1/8	-2-10M-2FRT	33.0	17.2	7.9	18
	1/4	-2-10M-4FRT	37.8	17.2	7.9	19
	3/8	-2-10M-6FRT	39.4	17.2	7.9	22
	1/2	-2-10M-8FRT	44.2	17.2	7.9	27
12	1/8	-2-12M-2FRT	35.5	22.8	8.3	22
	1/4	-2-12M-4FRT	40.3	22.8	9.5	22
	3/8	-2-12M-6FRT	41.9	22.8	9.5	22
	1/2	-2-12M-8FRT	46.7	22.8	9.5	27
	3/4	-2-12M-12FRT	49.0	22.8	9.5	35
15	1/2	-2-15M-8FRT	46.7	24.4	11.9	27
16	1/2	-2-16M-8FRT	48.4	24.4	11.9	27
	3/4	-2-16M-12FRT	49.7	24.4	12.7	35
20	1/2	-2-20M-8FRT	47.9	26.0	11.9	30
	3/4	-2-20M-12FRT	49.7	26.0	15.9	35
22	3/4	-2-22M-12FRT	49.7	26.0	15.9	35
	1	-2-22M-16FRT	57.9	26.0	18.3	41
25	3/4	-2-25M-12FRT	53.4	31.3	15.9	35
	1	-2-25M-16FRT	62.3	31.3	21.8	41

卡套接头

VCR接头

焊接接头

通用阀门

高纯阀门

卡套管

技术信息

## ISO/BSP 平行内螺纹 (RG, 压力表)

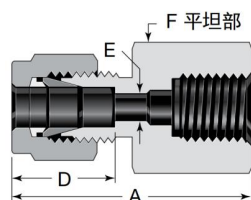

卡套管 外径	ISO螺纹 尺寸in.	基本 订购号	尺寸			
			A	D	E	F
英制尺寸, mm						
1/8	1/4	-2-2-4FRG	35.3	12.7	2.3	19.1
	3/8	-2-2-6FRG	38.7	12.7	2.3	23.8
1/4	1/4	-2-4-4FRG	37.6	15.2	4.8	19.1
	3/8	-2-4-6FRG	37.6	15.2	4.8	23.8
	1/2	-2-4-8FRG	43.4	15.2	4.8	27.0
5/16	1/4	-2-5-4FRG	38.4	16.3	5.6	19.1
	3/8	-2-5-6FRG	39.2	16.3	6.4	23.8
	1/2	-2-5-8FRG	40.9	16.3	7.1	27.0
3/8	1/4	-2-6-4FRG	39.1	16.8	5.6	19.1
	3/8	-2-6-6FRG	38.6	16.8	6.4	23.8
	1/2	-2-6-8FRG	41.9	16.8	7.1	27.0
1/2	1/4	-2-8-4FRG	41.9	22.9	5.6	22.2
	3/8	-2-8-6FRG	44.5	22.9	6.4	23.8
	1/2	-2-8-8FRG	48.3	22.9	7.1	27.0
公制尺寸, mm						
3	1/4	-2-3M-4FRG	35.3	12.9	2.4	19
6	1/4	-2-6M-4FRG	37.6	15.3	4.8	19
	3/8	-2-6M-6FRG	37.6	15.3	4.8	24
	1/2	-2-6M-8FRG	43.5	15.3	4.8	27
8	1/4	-2-8M-4FRG	38.5	16.2	6.4	19
	3/8	-2-8M-6FRG	36.2	16.2	6.4	24
	1/2	-2-8M-8FRG	41.0	16.2	6.4	27
10	1/4	-2-10M-4FRG	39.4	17.2	5.9	19
	3/8	-2-10M-6FRG	38.8	17.2	7.9	24
	1/2	-2-10M-8FRG	42.1	17.2	7.9	27
12	1/4	-2-12M-4FRG	41.9	22.8	5.9	22
	3/8	-2-12M-6FRG	44.4	22.8	7.9	24
	1/2	-2-12M-8FRG	48.2	22.8	9.5	27
20	1/2	-2-20M-8FRG	54.3	26.0	11.9	30
22	1/2	-2-22M-8FRG	54.3	26.0	11.9	30

卡套接头

VCR接头

焊接接头

通用阀门

高纯阀门

卡套管

技术信息

## 穿板 NPT内螺纹

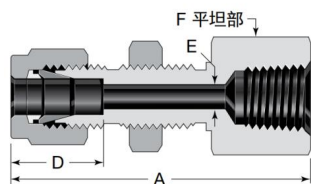

卡套管 外径	NPT 尺寸in.	基本 订购号	尺寸					
			A	D	E	F	面板孔尺寸	最大面板厚度
英制尺寸, mm								
1/16	1/16	-7-1-1FNT	26.2	8.6	1.3	11.1	5.2	3.2
	1/8	-7-1-2FNT	26.9	8.6	1.3	14.3	5.2	3.2
1/8	1/8	-7-2-2FNT	44.7	12.7	2.3	14.3	8.3	12.7
	1/4	-7-2-4FNT	49.6	12.7	2.3	19.1	8.3	12.7
3/16	1/8	-7-3-2FNT	45.5	13.7	3.0	14.3	9.9	12.7
1/4	1/8	-7-4-2FNT	47.0	15.2	4.8	15.9	11.5	10.2
	1/4	-7-4-4FNT	51.8	15.2	4.8	19.1	11.5	10.2
	3/8	-7-4-6FNT	53.3	15.2	4.8	22.2	11.5	10.2
	1/2	-7-4-8FNT	58.2	15.2	4.8	27.0	11.5	10.2
5/16	1/8	-7-5-2FNT	49.8	16.3	6.4	14.3	13.1	11.2
	1/4	-7-5-4FNT	60.5	16.3	6.4	19.1	13.1	11.2
3/8	1/8	-7-6-2FNT	50.3	16.8	7.1	15.9	14.5	11.2
	1/4	-7-6-4FNT	55.1	16.8	7.1	19.1	14.5	11.2
	3/8	-7-6-6FNT	56.6	16.8	7.1	22.2	14.5	11.2
	1/2	-7-6-8FNT	61.5	16.8	7.1	27.0	14.5	11.2
	3/4	-7-6-12FNT	65.3	16.8	7.1	33.3	14.5	11.2
1/2	1/4	-7-8-4FNT	60.2	22.9	10.4	23.8	19.4	12.7
	3/8	-7-8-6FNT	61.7	22.9	10.4	23.8	19.4	12.7
	1/2	-7-8-8FNT	66.5	22.9	10.4	27.0	19.4	12.7
	3/4	-7-8-12FNT	68.1	22.9	10.4	33.3	19.4	12.7
5/8	3/8	-7-10-6FNT	62.5	24.4	12.7	23.8	22.6	15.1
	1/2	-7-10-8FNT	67.3	24.4	12.7	27.0	22.6	15.1
3/4	1/2	-7-12-8FNT	72.2	24.4	15.7	27.0	25.8	19.8
	3/4	-7-12-12FNT	73.7	24.4	15.7	33.3	25.8	19.8
7/8	3/4	-7-14-12FNT	80.8	25.9	18.3	33.3	29.0	23.8
1	3/4	-7-16-12FNT	84.7	31.2	22.4	41.3	33.7	23.8
	1	-7-16-16FNT	93.5	31.2	22.4	41.3	33.7	23.8
公制尺寸, mm								
6	1/8	-7-6M-2FNT	47.2	15.3	4.8	16	11.5	10.2
	1/4	-7-6M-4FNT	51.8	15.3	4.8	19	11.5	10.2
8	1/8	-7-8M-2FNT	49.6	16.2	4.8	18	13.1	11.2
10	1/4	-7-10M-4FNT	55.2	17.2	7.9	22	16.3	11.2
12	3/8	-7-12M-6FNT	60.9	22.8	9.5	24	19.5	12.7
	1/2	-7-12M-8FNT	66.5	22.8	9.5	27	19.5	12.7

卡套接头

VCR接头

焊接接头

通用阀门

高纯阀门

卡套管

技术信息

## 卡套管变径接头 (英制)

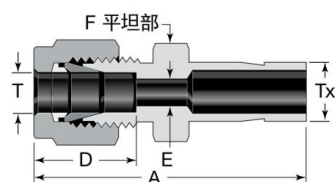

卡套管外径		基本 订购号	尺寸			
T	Tx		A	D	E	F
尺寸, mm						
1/16	1/8	-2-1-2TB	29.2	8.6	1.3	7.9
	3/16	-2-1-3TB	30.0	8.6	1.3	7.9
	1/4	-2-1-4TB	31.5	8.6	1.3	7.9
1/8	1/16	-2-2-1TB	29.0	12.7	0.8	11.1
	1/8	-2-2-2TB	33.5	12.7	2.0	11.1
	3/16	-2-2-3TB	34.3	12.7	2.3	11.1
	1/4	-2-2-4TB	36.1	12.7	2.3	11.1
	3/8	-2-2-6TB	37.6	12.7	2.3	11.1
	1/2	-2-2-8TB	44.2	12.7	2.3	14.3
3/16	1/8	-2-3-2TB	34.8	13.7	2.0	11.1
	1/4	-2-3-4TB	37.1	13.7	3.0	11.1
1/4	1/8	-2-4-2TB	36.8	15.2	2.0	12.7
	3/16	-2-4-3TB	37.6	15.2	3.0	12.7
	1/4	-2-4-4TB	39.1	15.2	4.3	12.7
	5/16	-2-4-5TB	39.9	15.2	4.8	12.7
	3/8	-2-4-6TB	40.6	15.2	4.8	12.7
	1/2	-2-4-8TB	46.2	15.2	4.8	14.3
	5/8	-2-4-10TB	48.0	15.2	4.8	17.5
5/16	3/4	-2-4-12TB	47.8	15.2	4.8	20.6
	3/8	-2-5-6TB	41.9	16.3	6.4	14.3
3/8	1/2	-2-5-8TB	47.5	16.3	6.4	14.3
	1/4	-2-6-4TB	41.4	16.8	4.3	15.9
	3/8	-2-6-6TB	43.2	16.8	6.9	15.9
	1/2	-2-6-8TB	48.5	16.8	7.1	15.9
	5/8	-2-6-10TB	50.3	16.8	7.1	17.5
	3/4	-2-6-12TB	50.3	16.8	7.1	20.6
1/2	1/4	-2-8-4TB	45.0	22.9	4.3	20.6
	3/8	-2-8-6TB	46.7	22.9	6.9	20.6
	1/2	-2-8-8TB	52.3	22.9	9.4	20.6
	5/8	-2-8-10TB	53.8	22.9	10.4	20.6
	3/4	-2-8-12TB	53.8	22.9	10.4	20.6
	1	-2-8-16TB	60.2	22.9	10.4	27.0
5/8	3/4	-2-10-12TB	54.6	24.4	12.7	23.8
	7/8	-2-10-14TB	56.1	24.4	12.7	23.8
	1	-2-10-16TB	61.0	24.4	12.7	27.0
3/4	1/2	-2-12-8TB	54.6	24.4	9.4	27.0
	3/4	-2-12-12TB	54.6	24.4	14.7	27.0
	1	-2-12-16TB	62.5	24.4	15.7	27.0

卡套接头

VCR接头

焊接接头

通用阀门

高纯阀门

卡套管

技术信息

## 卡套管变径接头 (公制)

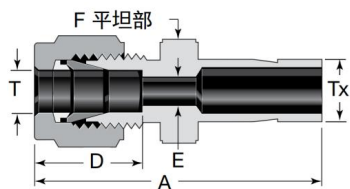

卡套管外径		基本 订购号	尺寸			
T	Tx		A	D	E	F
公制尺寸, mm						
2	3	-2-2M-3MTB	33.5	12.9	1.7	12
3	4	-2-3M-4MTB	35.0	12.9	2.4	12
	6	-2-3M-6MTB	36.1	12.9	2.4	12
	10	-2-3M-10MTB	38.4	12.9	2.4	14
4	6	-2-4M-6MTB	37.1	13.7	2.4	12
6	3	-2-6M-3MTB	36.9	15.3	1.9	14
	8	-2-6M-8MTB	39.9	15.3	4.8	14
	10	-2-6M-10MTB	40.7	15.3	4.8	14
	12	-2-6M-12MTB	46.3	15.3	4.8	14
	18	-2-6M-18MTB	49.6	15.3	4.8	22
8	6	-2-8M-6MTB	40.3	16.2	4.1	15
	10	-2-8M-10MTB	42.0	16.2	6.4	15
	12	-2-8M-12MTB	47.6	16.2	6.4	15
10	6	-2-10M-6MTB	42.4	17.2	4.1	18
	8	-2-10M-8MTB	43.4	17.2	5.6	18
	12	-2-10M-12MTB	49.8	17.2	7.9	18
	15	-2-10M-15MTB	51.3	17.2	7.9	18
	18	-2-10M-18MTB	51.3	17.2	7.9	22
12	6	-2-12M-6MTB-	44.9	22.8	4.1	22
	8	-2-12M-8MTB	45.9	22.8	5.6	22
	10	-2-12M-10MTB	46.7	22.8	7.1	22
	16	-2-12M-16MTB	53.8	22.8	9.5	22
	18	-2-12M-18MTB	53.8	22.8	9.5	22
	20	-2-12M-20MTB	56.1	22.8	9.5	22
	22	-2-12M-22MTB	56.1	22.8	9.5	24
25	-2-12M-25MTB	62.4	22.8	9.5	27	
16	12	-2-16M-12MTB	53.0	24.4	8.8	24
18	12	-2-18M-12MTB	54.6	24.4	8.8	27
	16	-2-18M-16MTB	56.1	24.4	12.0	27
	20	-2-18M-20MTB	57.6	24.4	15.1	27
	22	-2-18M-22MTB	57.6	24.4	15.1	27
	25	-2-18M-25MTB	62.4	24.4	15.1	27
20	16	-2-20M-16MTB	57.9	26.0	12.0	30
	18	-2-20M-18MTB	57.9	26.0	13.9	30
	22	-2-20M-22MTB	59.4	26.0	15.9	30
	25	-2-20M-25MTB	64.2	26.0	15.8	30
22	18	-2-22M-18MTB	57.9	26.0	13.9	30
	20	-2-22M-20MTB	59.4	26.0	15.5	30
	25	-2-22M-25MTB	64.2	26.0	18.3	30
25	18	-2-25M-18MTB	63.1	31.3	13.9	35
	20	-2-25M-20MTB	64.6	31.3	15.5	35

卡套接头

VCR接头

焊接接头

通用阀门

高纯阀门

卡套管

技术信息

## 卡套管变径接头 (公制变英制)

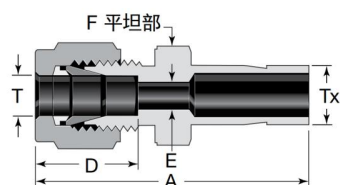

卡套管外径		基本 订购号	尺寸			
T	Tx, in.		A	D	E	F
尺寸, mm						
2	1/8	-2-2M-2TB	33.5	12.9	1.7	12
3	1/8	-2-3M-2TB	33.5	12.9	2.0	12
	1/4	-2-3M-4TB	36.1	12.9	2.4	12
4	1/4	-2-4M-4TB	37.1	13.7	2.4	12
6	1/8	-2-6M-2TB	36.9	15.3	2.0	14
	1/4	-2-6M-4TB	39.2	15.3	4.4	14
	5/16	-2-6M-5TB	39.9	15.3	4.8	14
	3/8	-2-6M-6TB	40.7	15.3	4.8	14
	1/2	-2-6M-8TB	46.3	15.3	4.8	14
8	1/4	-2-8M-4TB	40.3	16.2	4.4	15
	3/8	-2-8M-6TB	42.0	16.2	6.4	15
	1/2	-2-8M-8TB	47.6	16.2	6.4	15
10	3/8	-2-10M-6TB	44.2	17.2	6.8	18
	1/2	-2-10M-8TB	49.8	17.2	7.9	18
12	1/2	-2-12M-8TB	52.3	22.8	9.3	22
	3/4	-2-12M-12TB	53.8	22.8	9.5	22
18	3/4	-2-18M-12TB	56.1	24.4	14.7	27
	1	-2-18M-16TB	62.4	24.4	15.1	27
25	1	-2-25M-16TB	69.5	31.3	20.2	35

卡套接头

VCR接头

焊接接头

通用阀门

高纯阀门

卡套管

技术信息

### 卡套接头

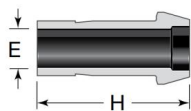

1 in./25 mm  
及以下

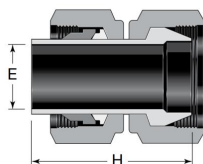

1 in./25mm 以上

卡套管 外径	基本 订购号	尺寸	
		E	H
英制尺寸, mm			
1/16	-6-1	0.8	13.7
1/8	-6-2	2.0	22.4
1/4	-6-4	4.3	24.6
5/16	-6-5	5.6	25.9
3/8	-6-6	6.9	26.2
1/2	-6-8	9.4	35.8
5/8	-6-10	11.9	37.8
3/4	-6-12	14.7	37.3
1	-6-16	20.3	48.0
1 1/4	-6-20	25.9	69.1
1 1/2	-6-24	31.8	84.1

卡套管 外径	基本 订购号	尺寸	
		E	H
公制尺寸, mm			
3	-6-3M	1.9	22.2
6	-6-6M	4.1	24.6
8	-6-8M	5.6	25.9
10	-6-10M	7.1	26.1
12	-6-12M	8.8	35.8
15	-6-15M	11.2	37.8
16	-6-16M	12.0	37.8
18	-6-18M	13.9	37.8
20	-6-20M	15.5	39.4
25	-6-25M	19.9	49.3
28	-6-28M	22.5	63.5
30	-6-30M	24.3	67.6
32	-6-32M	26.5	69.7
38	-6-38M	31.6	81.9

### 变径孔口连接接头

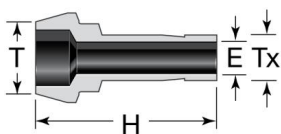

卡套管外径		基本 订购号	尺寸	
T	Tx		E	H
英制尺寸, mm				
1/8	1/16	-6-2-1	0.8	17.3
1/4	1/16	-6-4-1	0.8	18.0
	1/8	-6-4-2	2.0	22.6
3/8	1/8	-6-6-2	2.0	23.1
	1/4	-6-6-4	4.3	24.9
1/2	1/4	-6-8-4	4.3	29.2
	3/8	-6-8-6	6.9	30.5
3/4	1/2	-6-12-8	9.4	37.8
1	1/2	-6-16-8	9.4	42.9
	3/4	-6-16-12	14.7	43.7

卡套管外径		基本 订购号	尺寸	
T	Tx		E	H
公制尺寸, mm				
6	3	-6-6M-3M	1.9	22.6
8	6	-6-8M-6M	4.1	24.7
10	6	-6-10M-6M	4.1	25.0
	8	-6-10M-8M	5.6	26.3
12	6	-6-12M-6M	4.1	29.6
	8	-6-12M-8M	5.6	29.8
	10	-6-12M-10M	7.1	30.4
16	12	-6-16M-12M	8.8	36.2
28	25	-6-28M-25M	19.8	56.5
32	25	-6-32M-25M	19.8	60.3
38	25	-6-38M-25M	19.8	65.8

卡套接头

VCR接头

焊接接头

通用阀门

高纯阀门

卡套管

技术信息

## 管帽

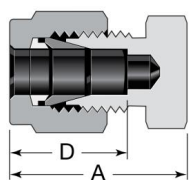

卡套管 外径	基本 订购号	A	D
英制尺寸, in.			
1/16	-C-1	15.0	8.6
1/8	-C-2	20.1	12.7
3/16	-C-3	21.3	13.7
1/4	-C-4	23.4	15.2
5/16	-C-5	24.4	16.3
3/8	-C-6	25.7	16.8
1/2	-C-8	29.2	22.9
5/8	-C-10	30.0	24.4
3/4	-C-12	31.5	24.4
7/8	-C-14	34.0	25.9
1	-C-16	38.4	31.2
1 1/8	-C-18	38.4	31.2
1 1/4	-C-20	53.3	41.1
1 1/2	-C-24	64.5	50.0

卡套管 外径	基本 订购号	A	D
公制尺寸, mm			
2	-C-2M	20.1	12.9
3	-C-3M	20.1	12.9
4	-C-4M	21.3	13.7
6	-C-6M	23.1	15.3
8	-C-8M	24.5	16.2
10	-C-10M	26.6	17.2
12	-C-12M	29.1	22.8
14	-C-14M	29.9	24.4
15	-C-15M	29.9	24.4
16	-C-16M	29.9	24.4
18	-C-18M	31.4	24.4
20	-C-20M	34.0	26.0
22	-C-22M	34.0	26.0
25	-C-25M	38.5	31.3
28	-C-28M	48.5	36.6
30	-C-30M	53.4	39.6
32	-C-32M	55.8	42.0
38	-C-38M	65.4	49.4

## 堵塞

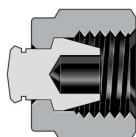

卡套管 外径	基本 订购号
尺寸, in.	
1/16	-P-1
1/8	-P-2
3/16	-P-3
1/4	-P-4
5/16	-P-5
3/8	-P-6
1/2	-P-8
5/8	-P-10
3/4	-P-12
7/8	-P-14
1	-P-16
1 1/4	-P-20
1 1/2	-P-24

卡套管 外径	基本 订购号
尺寸, mm	
2	-P-2M
3	-P-3M
4	-P-4M
6	-P-6M
8	-P-8M
10	-P-10M
12	-P-12M
14	-P-14M
15	-P-15M
16	-P-16M
18	-P-18M
20	-P-20M
22	-P-22M
25	-P-25M
28	-P-28M
30	-P-30M
32	-P-32M
38	-P-38M

弯头

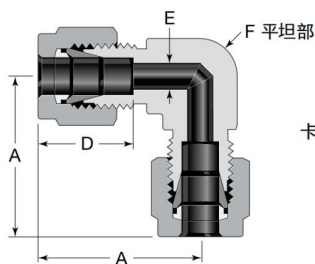

卡套管端口是相同的。

卡套管 外径	基本 订购号	尺寸			
		A	D	E	F
英制尺寸, mm					
1/16	-9-1	17.8	8.6	1.3	9.5
1/8	-9-2	22.4	12.7	2.3	9.5
3/16	-9-3	25.4	13.7	3.0	12.7
1/4	-9-4	26.9	15.2	4.8	12.7
5/16	-9-5	28.7	16.3	6.4	14.3
3/8	-9-6	30.5	16.8	7.1	15.9
1/2	-9-8	36.1	22.9	10.4	20.6
5/8	-9-10	38.1	24.4	12.7	23.8
3/4	-9-12	39.9	24.4	15.7	27.0
7/8	-9-14	44.7	25.9	18.3	34.9
1	-9-16	49.0	31.2	22.4	34.9
1 1/8	-9-18	55.1	31.2	24.6	42.9
1 1/4	-9-20	66.5	41.1	27.7	42.9
1 1/2	-9-24	78.0	50.0	34.0	50.8

卡套管 外径	基本 订购号	尺寸			
		A	D	E	F
公制尺寸, mm					
3	-9-3M	22.3	12.9	2.4	9.5
4	-9-4M	25.4	13.7	2.4	12.7
6	-9-6M	27.0	15.3	4.8	12.7
8	-9-8M	28.8	16.2	6.4	14.3
10	-9-10M	31.5	17.2	7.9	17.5
12	-9-12M	36.0	22.8	9.5	20.6
14	-9-14M	38.0	24.4	11.0	23.8
15	-9-15M	38.8	24.4	11.9	23.8
16	-9-16M	38.0	24.4	12.7	23.8
18	-9-18M	39.8	24.4	15.1	27.0
20	-9-20M	44.6	26.0	15.9	34.9
22	-9-22M	44.6	26.0	18.3	34.9
25	-9-25M	49.1	31.3	21.8	34.9
28	-9-28M	64.0	36.6	21.8	42.9
30	-9-30M	69.9	39.6	26.2	42.9
32	-9-32M	72.3	42.0	28.6	42.9
38	-9-38M	84.0	49.4	33.7	50.8

卡套接头

VCR接头

焊接接头

通用阀门

高纯阀门

卡套管

技术信息

## NPT外螺纹弯头

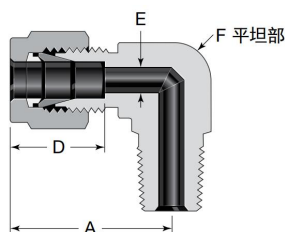

卡套管 外径	NPT 尺寸	基本 订购号	尺寸			
			A	D	E	F
尺寸, in.						
1/16	1/16	-9-1-1NT	19.1	8.6	1.3	11.1
	1/8	-9-1-2NT	19.1	8.6	1.3	11.1
1/8	1/16	-9-2-1NT	23.6	12.7	2.4	11.1
	1/8	-9-2-2NT	23.6	12.7	2.4	11.1
3/16	1/8	-9-3-2NT	25.4	13.7	3.0	12.7
	1/4	-9-3-4NT	25.4	13.7	3.0	12.7
1/4	1/16	-9-4-1NT	26.9	15.2	3.0	12.7
	1/8	-9-4-2NT	26.9	15.2	4.8	12.7
	1/4	-9-4-4NT	26.9	15.2	4.8	12.7
	3/8	-9-4-6NT	29.7	15.2	4.8	17.5
5/16	1/2	-9-4-8NT	31.8	15.2	4.8	20.6
	1/8	-9-5-2NT	28.7	16.3	4.8	14.3
	1/4	-9-5-4NT	28.7	16.3	6.4	14.3
	3/8	-9-5-6NT	30.5	16.3	6.4	17.5
3/8	1/8	-9-6-2NT	30.5	16.8	4.8	15.9
	1/4	-9-6-4NT	30.5	16.8	7.1	15.9
	3/8	-9-6-6NT	31.2	16.8	7.1	17.5
	1/2	-9-6-8NT	33.3	16.8	7.1	20.6
1/2	3/4	-9-6-12NT	37.1	16.8	7.1	27.0
	1/4	-9-8-4NT	36.1	22.9	7.1	20.6
	3/8	-9-8-6NT	36.1	22.9	9.7	20.6
	1/2	-9-8-8NT	36.1	22.9	10.4	20.6
5/8	3/4	-9-8-12NT	39.9	22.9	10.4	27.0
	3/8	-9-10-6NT	38.1	24.4	9.7	23.8
	1/2	-9-10-8NT	38.1	24.4	11.9	23.8
3/4	3/4	-9-10-12NT	39.9	24.4	12.7	27.0
	1/2	-9-12-8NT	39.9	24.4	11.9	27.0
7/8	3/4	-9-12-12NT	39.9	24.4	15.7	27.0
	3/4	-9-14-12NT	44.7	25.9	15.7	34.9
1	3/4	-9-16-12NT	49.0	31.2	15.7	34.9
	1	-9-16-16NT	49.0	31.2	22.4	34.9
1 1/4	1 1/4	-9-20-20NT	66.5	41.1	27.7	42.9
1 1/2	1 1/2	-9-24-24NT	78.0	50.0	34.0	50.8

卡套管 外径	NPT 尺寸 in.	基本 订购号	尺寸			
			A	D	E	F, in.
尺寸, mm						
3	1/8	-9-3M-2NT	23.6	12.9	2.4	11.1
	1/4	-9-3M-4NT	24.6	12.9	2.4	12.7
4	1/8	-9-4M-2NT	25.4	13.7	2.4	12.7
	1/4	-9-4M-4NT	25.4	13.7	2.4	12.7
6	1/8	-9-6M-2NT	27.0	15.3	4.8	12.7
	1/4	-9-6M-4NT	27.0	15.3	4.8	12.7
	3/8	-9-6M-6NT	29.8	15.3	4.8	17.5
8	1/2	-9-6M-8NT	31.8	15.3	4.8	20.6
	1/8	-9-8M-2NT	28.8	16.2	4.8	14.3
	1/4	-9-8M-4NT	28.8	16.2	6.4	14.3
	3/8	-9-8M-6NT	30.6	16.2	6.4	17.5
	1/2	-9-8M-8NT	32.6	16.2	6.4	20.6
10	1/8	-9-10M-2NT	31.5	17.2	4.8	17.5
	1/4	-9-10M-4NT	31.5	17.2	7.1	17.5
	3/8	-9-10M-6NT	31.5	17.2	7.9	17.5
	1/2	-9-10M-8NT	33.5	17.2	7.9	20.6
12	1/8	-9-12M-2NT	36.0	22.8	4.8	20.6
	1/4	-9-12M-4NT	36.0	22.8	7.1	20.6
	3/8	-9-12M-6NT	36.0	22.8	9.5	20.6
	1/2	-9-12M-8NT	36.0	22.8	9.5	20.6
15	3/4	-9-12M-12NT	39.8	22.8	9.5	27.0
	1/2	-9-15M-8NT	38.0	24.4	11.9	23.8
16	1/4	-9-16M-4NT	38.0	24.4	7.1	23.8
	3/8	-9-16M-6NT	38.0	24.4	9.5	23.8
	1/2	-9-16M-8NT	38.0	24.4	11.9	23.8
18	3/4	-9-16M-12NT	39.8	24.4	12.7	27.0
	1/2	-9-18M-8NT	39.8	24.4	11.9	27.0
	3/4	-9-18M-12NT	39.8	24.4	15.1	27.0
20	1/2	-9-20M-8NT	44.6	26.0	11.9	34.9
	3/4	-9-20M-12NT	44.6	26.0	15.9	34.9
22	3/4	-9-22M-12NT	44.6	26.0	15.9	34.9
	1	-9-22M-16NT	44.6	26.0	18.3	34.9
25	3/4	-9-25M-12NT	49.1	31.3	15.9	34.9
	1	-9-25M-16NT	49.1	31.3	21.8	34.9
30	1 1/4	-9-30M-20NT	69.9	39.6	26.2	42.9
32	1 1/4	-9-32M-20NT	72.3	42.0	27.8	42.9
38	1 1/2	-9-38M-24NT	84.0	49.4	33.7	50.8

## RT外螺纹弯头

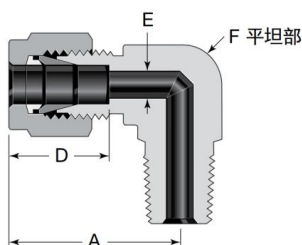

卡套管 外径	ISO 螺纹 尺寸	基本 订购号	尺寸			
			A	D	E	F
英制尺寸, mm						
1/8	1/8	-9-2-2RT	23.6	12.7	2.4	11.1
	1/4	-9-2-4RT	24.6	12.7	2.4	12.7
1/4	1/8	-9-4-2RT	26.9	15.2	4.8	12.7
	1/4	-9-4-4RT	26.9	15.2	4.8	12.7
	3/8	-9-4-6RT	29.7	15.2	4.8	17.5
	1/2	-9-4-8RT	31.8	15.2	4.8	20.6
5/16	1/4	-9-5-4RT	28.7	16.3	6.4	14.3
3/8	1/8	-9-6-2RT	30.5	16.8	4.8	15.9
	1/4	-9-6-4RT	30.5	16.8	7.1	15.9
	3/8	-9-6-6RT	31.2	16.8	7.1	17.5
1/2	3/8	-9-8-6RT	36.1	22.9	9.7	20.6
	1/2	-9-8-8RT	36.1	22.9	10.4	20.6
3/4	1/2	-9-12-8RT	39.9	24.4	11.9	27.0
1	1	-9-16-16RT	49.0	31.2	22.4	34.9

卡套管 外径	ISO 螺纹 尺寸 in.	基本 订购号	尺寸			
			A	D	E	F
公制尺寸, mm						
3	1/8	-9-3M-2RT	23.6	12.9	2.4	11.1
	1/4	-9-3M-4RT	24.6	12.9	2.4	12.7
4	1/8	-9-4M-2RT	25.4	13.7	2.4	12.7
	1/4	-9-4M-4RT	25.4	13.7	2.4	12.7
6	1/8	-9-6M-2RT	27.0	15.3	4.8	12.7
	1/4	-9-6M-4RT	27.0	15.3	4.8	12.7
	3/8	-9-6M-6RT	29.8	15.3	4.8	17.5
	1/2	-9-6M-8RT	31.8	15.3	4.8	20.6
8	1/8	-9-8M-2RT	28.8	16.2	4.8	14.3
	1/4	-9-8M-4RT	28.8	16.2	6.4	14.3
	3/8	-9-8M-6RT	30.6	16.2	6.4	17.5
	1/2	-9-8M-8RT	32.6	16.2	6.4	20.6
10	1/8	-9-10M-2RT	31.5	17.2	4.8	17.5
	1/4	-9-10M-4RT	31.5	17.2	7.1	17.5
	3/8	-9-10M-6RT	31.5	17.2	7.9	17.5
	1/2	-9-10M-8RT	33.5	17.2	7.9	20.6
	3/4	-9-10M-12RT	33.5	17.2	7.9	20.6
12	1/8	-9-12M-2RT	36.0	22.8	4.8	20.6
	1/4	-9-12M-4RT	36.0	22.8	7.1	20.6
	3/8	-9-12M-6RT	36.0	22.8	9.5	20.6
	1/2	-9-12M-8RT	36.0	22.8	9.5	20.6
	3/4	-9-12M-12RT	39.8	22.8	9.5	27.0
14	1/2	-9-14M-8RT	38.1	24.4	11.1	23.8
15	1/2	-9-15M-8RT	38.1	24.4	11.9	23.8
16	1/4	-9-16M-4RT	38.0	24.4	7.1	23.8
	3/8	-9-16M-6RT	38.0	24.4	9.5	23.8
	1/2	-9-16M-8RT	38.0	24.4	11.9	23.8
	3/4	-9-16M-12RT	39.8	24.4	12.7	27.0
18	1/2	-9-18M-8RT	39.8	24.4	11.9	27.0
	3/4	-9-18M-12RT	39.8	24.4	15.1	27.0
20	1/2	-9-20M-8RT	44.6	26.0	11.9	34.9
	3/4	-9-20M-12RT	44.6	26.0	15.9	34.9
22	3/4	-9-22M-12RT	44.6	26.0	15.9	34.9
	1	-9-22M-16RT	44.6	26.0	18.3	34.9
25	3/4	-9-25M-12RT	49.1	31.3	15.9	34.9
	1	-9-25M-16RT	49.1	31.3	21.8	34.9
28	1	-9-28M-16RT	64.0	36.6	21.8	42.9

卡套接头

VCR接头

焊接接头

通用阀门

高纯阀门

卡套管

技术信息

## 可定ISO/BSP 平行螺纹 (PR) 弯头

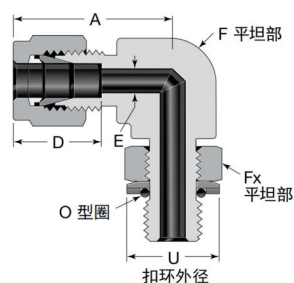

卡套管 外径	ISO 螺纹 尺寸 in.	基本 订购号	尺寸				
			A	D	E	F	Fx
英制尺寸, mm							
1/4	1/8	-9-4-2PR	26.9	15.2	4.1	12.7	14.3
	1/4	-9-4-4PR	29.0	15.2	4.8	15.9	19.1
3/8	1/4	-9-6-4PR	30.5	16.8	5.8	15.9	19.1
	3/8	-9-6-6PR	33.3	16.8	7.1	20.6	22.2
1/2	1/4	-9-8-4PR	36.1	22.9	5.8	20.6	19.1
	3/8	-9-8-6PR	36.1	22.9	7.9	20.6	22.2
	1/2	-9-8-8PR	38.1	22.9	10.4	23.8	27.0
5/8	1/2	-9-10-8PR	38.1	24.4	11.9	23.8	27.0
3/4	1/2	-9-12-8PR	39.9	24.4	11.9	27.0	27.0
	3/4	-9-12-12PR	39.9	24.4	15.7	27.0	34.9
1	3/4	-9-16-12PR	49.0	31.2	15.7	34.9	34.9
	1	-9-16-16PR	49.0	31.2	19.8	34.9	41.3
公制尺寸, mm							
6	1/8	-9-6M-2PR	27.0	15.3	4.0	12.7	14.3
	1/4	-9-6M-4PR	29.0	15.3	4.8	15.9	19.1
8	1/8	-9-8M-2PR	28.8	16.2	4.0	14.3	14.3
	1/4	-9-8M-4PR	29.9	16.2	5.9	15.9	19.1
10	1/4	-9-10M-4PR	33.5	17.2	5.9	20.6	19.1
	3/8	-9-10M-6PR	33.5	17.2	7.9	20.6	22.2
12	1/4	-9-12M-4PR	36.0	22.8	5.9	20.6	19.1
	3/8	-9-12M-6PR	36.0	22.8	7.9	20.6	22.2
	1/2	-9-12M-8PR	38.0	22.8	9.5	23.8	27.0
	3/4	-9-12M-12PR	39.8	22.8	9.5	27.0	34.9

卡套接头

VCR接头

焊接接头

通用阀门

高纯阀门

卡套管

技术信息

## 可定位SAE/MS 直螺纹 (ST) 弯头

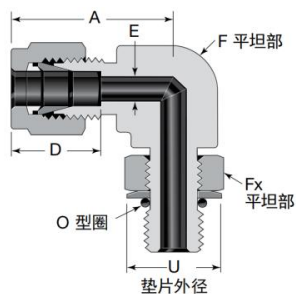

卡套管 外径	SAE/MS 螺纹 尺寸	基本 订购号	尺寸				
			A	D	E	F,in.	Fx,in.
尺寸, mm							
1/4	7/16-20	-9-4-4ST	28.4	15.2	4.8	12.7	14.3
	9/16-18	-9-4-6ST	30.5	15.2	4.8	15.9	17.5
5/16	1/2-20	-9-5-5ST	30.2	16.3	5.8	14.3	15.9
	7/16-20	-9-6-4ST	33.3	16.8	5.1	15.9	14.3
3/8	9/16-18	-9-6-6ST	32.0	16.8	7.1	15.9	17.5
	3/4-16	-9-6-8ST	34.8	16.8	7.1	20.6	22.2
1/2	9/16-18	-9-8-6ST	37.6	22.9	7.1	20.6	17.5
	3/4-16	-9-8-8ST	37.6	22.9	10.4	20.6	22.2
5/8	7/8-14	-9-10-10ST	39.6	24.4	12.7	23.8	25.4
3/4	1 1/16-12	-9-12-12ST	41.4	24.4	15.7	27.0	31.8
7/8	1 3/16-12	-9-14-14ST	43.2	25.9	18.3	30.2	34.9
1	1 5/16-12	-9-16-16ST	50.5	31.2	22.4	34.9	38.1
1 1/4	1 5/8-12	-9-20-20ST	67.8	41.1	27.7	42.9	47.6
1 1/2	1 7/8-12	-9-24-24ST	78.0	50.0	34.0	50.8	54.0

## 卡套管承插焊弯头

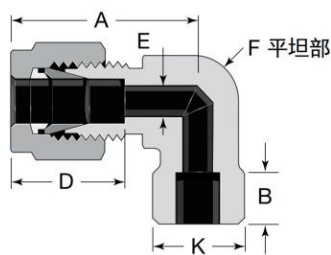

卡套管 外径	承插焊 尺寸	基本 订购号	尺寸					
			A	B	D	E	F	K
尺寸, mm								
1/8	1/8	-9-2-2TW	16.8	2.5	12.7	2.3	9.5	9.7
3/16	3/16	-9-3-3TW	18.3	4.8	13.7	3.3	11.1	11.2
1/4	1/4	-9-4-4TW	26.9	7.1	15.2	4.8	12.7	12.7
3/8	3/8	-9-6-6TW	30.5	7.9	16.8	7.1	15.9	15.7
1/2	1/2	-9-8-8TW	36.1	9.7	22.9	10.4	20.6	20.6
5/8	5/8	-9-10-10TW	29.5	10.4	24.4	12.7	27.0	23.9
3/4	3/4	-9-12-12TW	39.9	11.2	24.4	15.7	27.0	26.9
1	1	-9-16-16TW	49.0	15.7	31.2	22.4	34.9	35.1

## 公称管外焊弯头

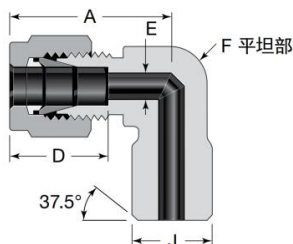

卡套管 外径	公称管 焊接 尺寸	基本 订购号	尺寸				
			A	D	E	F	J
尺寸, mm							
1/8	1/8	-9-2-2PW	23.4	12.7	2.3	11.1	10.3
3/16	1/8	-9-3-2PW	25.7	13.7	3.3	12.7	10.3
1/4	1/8	-9-4-2PW	26.9	15.2	4.8	12.7	10.3
	1/4	-9-4-4PW	26.9	15.2	4.8	12.7	13.7
3/8	1/4	-9-6-4PW	30.5	16.8	7.1	15.9	13.7
1/2	3/8	-9-8-6PW	34.8	22.9	10.4	19.1	17.2
	1/2	-9-8-8PW	36.1	22.9	10.4	20.6	21.3
5/8	1/2	-9-10-8PW	36.3	24.4	12.7	23.8	21.3
3/4	3/4	-9-12-12PW	39.9	24.4	15.7	27.0	26.7
1	3/4	-9-16-12PW	49.3	31.2	22.4	34.9	26.7
	1	-9-16-16PW	49.3	31.2	22.4	34.9	33.4

卡套接头

VCR接头

焊接接头

通用阀门

高纯阀门

卡套管

技术信息

## NPT内螺纹弯头

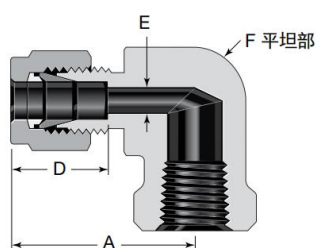

卡套管 外径	NPT 尺寸	基本 订购号	尺寸			
			A	D	E	F
英制尺寸, mm.						
1/16	1/16	-9-1-1FNT	18.0	8.6	1.3	11.1
	1/8	-9-1-2FNT	20.6	8.6	1.3	14.3
1/8	1/8	-9-2-2FNT	24.6	12.7	2.3	14.3
	1/4	-9-2-4FNT	27.4	12.7	2.3	17.5
3/16	1/8	-9-3-2FNT	25.4	13.7	3.0	12.7
1/4	1/8	-9-4-2FNT	26.9	15.2	4.8	14.3
	1/4	-9-4-4FNT	29.7	15.2	4.8	17.5
	3/8	-9-4-6FNT	31.8	15.2	4.8	20.6
	1/2	-9-4-8FNT	34.5	15.2	4.8	25.4
5/16	1/8	-9-5-2FNT	28.7	16.3	6.4	14.3
	1/4	-9-5-4FNT	30.5	16.3	6.4	17.5
3/8	1/8	-9-6-2FNT	30.5	16.8	7.1	15.9
	1/4	-9-6-4FNT	31.2	16.8	7.1	17.5
	3/8	-9-6-6FNT	33.3	16.8	7.1	20.6
	1/2	-9-6-8FNT	36.1	16.8	7.1	25.4
1/2	1/4	-9-8-4FNT	36.1	22.9	10.4	20.6
	3/8	-9-8-6FNT	36.1	22.9	10.4	20.6
	1/2	-9-8-8FNT	38.9	22.9	10.4	25.4
5/8	3/8	-9-10-6FNT	38.1	24.4	12.7	23.8
	1/2	-9-10-8FNT	39.9	24.4	12.7	27.0
3/4	1/2	-9-12-8FNT	39.9	24.4	15.7	27.0
	3/4	-9-12-12FNT	44.7	24.4	15.7	34.9
7/8	3/4	-9-14-12FNT	44.7	25.9	18.3	34.9
1	3/4	-9-16-12FNT	49.0	31.2	22.4	34.9
	1	-9-16-16FNT	53.6	31.2	22.4	42.9

卡套管 外径	NPT 尺寸	基本 订购号	尺寸			
			A	D	E	F
公制尺寸, mm						
6	1/8	-9-6M-2FNT	27.0	15.3	4.8	12.7
	1/4	-9-6M-4FNT	29.8	15.3	4.8	17.5
8	1/8	-9-8M-2FNT	28.8	16.2	4.8	14.3
	1/4	-9-8M-4FNT	30.6	16.2	6.4	17.5
10	1/4	-9-10M-4FNT	33.5	17.2	7.9	20.6
	3/8	-9-10M-6FNT	33.5	17.2	7.9	20.6
	1/2	-9-10M-8FNT	36.6	17.2	7.9	25.4
12	1/4	-9-12M-4FNT	36.0	22.8	7.9	20.6
	3/8	-9-12M-6FNT	36.0	22.8	9.5	20.6
	1/2	-9-12M-8FNT	38.8	22.8	9.5	25.4
16	3/8	-9-16M-6FNT	39.5	24.4	9.5	27.0
	1/2	-9-16M-8FNT	39.5	24.4	12.7	27.0

## NPT外螺纹45°弯头

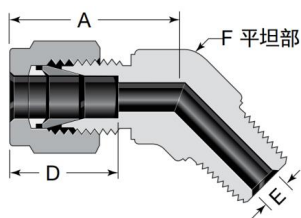

卡套管 外径	NPT 尺寸	基本 订购号	尺寸			
			A	D	E	F
英制尺寸, mm						
1/16	1/16	-5-1-1NT	15.7	8.6	1.3	9.5
1/8	1/8	-5-2-2NT	20.8	12.7	2.3	11.1
3/16	1/8	-5-3-2NT	21.6	13.7	3.0	11.1
1/4	1/8	-5-4-2NT	24.6	15.2	4.8	12.7
	1/4	-5-4-4NT	24.6	15.2	4.8	12.7
5/16	1/8	-5-5-2NT	24.1	16.3	4.8	14.3
3/8	1/8	-5-6-2NT	27.9	16.8	4.8	15.9
	1/4	-5-6-4NT	27.9	16.8	7.1	15.9
	3/8	-5-6-6NT	29.2	16.8	7.1	20.6
1/2	3/8	-5-8-6NT	32.0	22.9	9.7	20.6
5/8	1/2	-5-10-8NT	30.7	24.4	11.9	23.8
3/4	3/4	-5-12-12NT	34.0	24.4	15.7	27.0
7/8	3/4	-5-14-12NT	40.4	25.9	15.7	31.8
1	1	-6-16-16NT	40.4	31.2	22.4	34.9
公制尺寸, mm						
6	1/8	-5-6M-2NT	23.4	15.3	4.8	12.7
	1/4	-5-6M-4NT	23.4	15.3	4.8	12.7
8	1/8	-5-8M-2NT	24.3	16.2	4.8	15.9
10	1/4	-5-10M-4NT	26.6	17.2	7.9	17.5
12	3/8	-5-12M-6NT	29.1	22.8	9.5	20.6
	1/2	-5-12M-8NT	30.7	22.8	9.5	20.6
16	1/2	-5-16M-8NT	30.7	24.4	11.9	23.8

## 可定位SAE/MS 直螺纹 (ST) 45°弯头

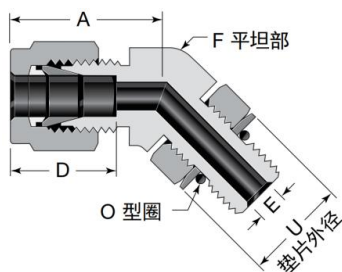

卡套管 外径	SAE/MS 螺纹 尺寸	基本 订购号	尺寸			
			A	D	E	F
尺寸, mm						
1/4	7/16-20	-5-4-4ST	25.7	15.2	4.8	12.7
3/8	9/16-18	-5-6-6ST	27.9	16.8	7.1	15.9
1/2	3/4-16	-5-8-8ST	32.0	22.9	10.4	20.6
3/4	1 1/16-12	-5-12-12ST	39.9	24.4	15.7	27.0
1	1 5/16-12	-5-16-16ST	47.5	31.2	22.4	33.3

## 三通联合接头

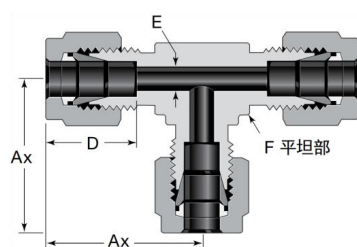

卡套管 外径	基本 订购号	尺寸			
		Ax	D	E	F
英制尺寸, mm					
1/16	-3-1	17.8	8.6	1.3	9.5
1/8	-3-2	22.4	12.7	2.3	9.5
3/16	-3-3	24.4	13.7	3.0	11.1
1/4	-3-4	26.9	15.2	4.8	12.7
5/16	-3-5	29.7	16.2	6.4	15.9
3/8	-3-6	30.5	16.8	7.1	15.9
1/2	-3-8	36.1	22.9	10.4	20.6
5/8	-3-10	38.9	24.4	12.7	25.4
3/4	-3-12	39.9	24.4	15.7	27.0
7/8	-3-14	44.7	25.9	18.3	34.9
1	-3-16	49.0	31.2	22.4	34.9
1 1/8	-3-18	55.1	31.2	24.6	42.9
1 1/4	-3-20	66.5	41.1	27.7	42.9
1 1/2	-3-24	78.0	50.0	34.0	50.8

卡套管 外径	基本 订购号	尺寸			
		Ax	D	E	F
公制尺寸, mm					
2	-3-2M	22.3	12.9	1.7	9.5
3	-3-3M	22.3	12.9	2.4	9.5
4	-3-4M	25.4	13.7	2.4	12.7
6	-3-6M	27.0	15.3	4.8	12.7
8	-3-8M	29.9	16.2	6.4	15.9
10	-3-10M	31.5	17.2	7.9	17.5
12	-3-12M	36.0	22.8	9.5	20.6
14	-3-14M	38.8	24.4	11.1	25.4
15	-3-15M	38.8	24.4	11.9	25.4
16	-3-16M	38.8	24.4	12.7	25.4
18	-3-18M	38.8	24.4	15.1	27.0
20	-3-20M	44.6	26.0	15.9	34.9
22	-3-22M	44.6	26.0	18.3	34.9
25	-3-25M	49.1	31.3	21.8	34.9
28	-3-28M	64.0	36.6	21.8	42.9
30	-3-30M	69.9	39.6	26.2	42.9
32	-3-32M	72.3	42.0	28.6	42.9
38	-3-38M	84.0	49.4	33.7	50.8

## 三通变径联合接头

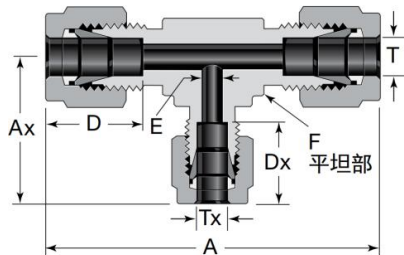

卡套管外径		基本 订购号	尺寸					
T	Tx		A	Ax	D	Dx	E	F
英制尺寸, mm								
1/4	1/8	-3-4-4-2	53.4	24.4	15.2	12.7	2.3	12.7
3/8	1/4	-3-6-6-4	71	29.0	16.8	15.2	4.8	15.9
1/2	1/4	-3-8-8-4	72.2	31.8	22.9	15.2	4.8	20.6
	3/8	-3-8-8-6	72.2	33.3	22.9	16.8	7.1	20.6
5/8	3/8	-3-10-10-6	77.8	36.1	24.4	16.8	7.1	25.4
	1/2	-3-10-10-8	77.8	38.9	24.4	22.9	10.4	25.4
3/4	1/4	-3-12-12-4	79.2	35.1	24.4	15.2	4.8	27.0
	3/8	-3-12-12-6	79.2	36.9	24.4	16.8	7.1	27.0
	1/2	-3-12-12-8	79.2	39.6	24.4	22.9	10.4	27.0
	5/8	-3-12-12-10	79.2	39.6	24.4	24.4	12.7	27.0
7/8	1/4	-3-14-14-4	89.4	40.4	25.9	15.2	4.8	34.9
	3/8	-3-14-14-6	89.4	41.9	25.9	16.8	7.1	34.9
1	1/4	-3-16-16-4	98.6	40.4	31.2	15.2	4.8	34.9
	3/8	-3-16-16-6	98.6	41.9	31.2	16.8	7.1	34.9
	1/2	-3-16-16-8	98.6	44.7	31.2	22.9	10.4	34.9
	5/8	-3-16-16-10	98.6	44.7	31.2	24.4	12.7	34.9
	3/4	-3-16-16-12	98.6	44.7	31.2	24.4	15.7	34.9
	7/8	-3-16-16-14	98.6	44.7	31.2	25.9	18.3	34.9
1 1/4	1	-3-20-20-16	135.6	55.1	41.2	31.3	22.4	42.9
1 1/2	1	-3-24-24-16	157.4	60.0	50.0	31.3	22.4	50.8

卡套管外径		基本 订购号	尺寸					
T	Tx		A	Ax	D	Dx	E	F
公制尺寸, mm								
3	6	-3-3M-3M-6M	49.4	27.0	12.9	15.3	2.4	12.7
6	3	-3-6M-6M-3M	54	25.4	15.3	12.9	2.4	12.7
	8	-3-6M-6M-8M	56	28.8	15.3	16.2	4.8	14.3
8	6	-3-8M-8M-6M	60	29.0	16.2	15.3	4.8	15.9
	12	-3-8M-8M-12M	71	36.0	16.2	22.8	6.4	20.6
10	6	-3-10M-10M-6M	63	29.9	17.2	15.3	4.8	17.5
	8	-3-10M-10M-8M	63	30.7	17.2	16.2	6.4	17.5
12	6	-3-12M-12M-6M	72	31.8	22.8	15.3	4.8	20.6
	8	-3-12M-12M-8M	72	35.2	22.8	16.2	6.4	20.6
	14	-3-12M-12M-14M	76	38.0	22.8	24.4	9.5	25.4
	18	-3-12M-12M-18M	79.6	39.8	22.8	24.4	9.5	27.0
14	8	-3-14M-14M-8M	76	37.2	24.4	16.2	6.4	25.4
	10	-3-14M-14M-10M	76	38.0	24.4	17.2	7.9	25.4
15	12	-3-15M-15M-12M	77.6	38.8	24.4	22.8	9.5	25.4
16	8	-3-16M-16M-8M	76	38.8	24.4	24.4	6.4	25.4
	12	-3-16M-16M-12M	77.6	38.9	24.4	22.8	9.5	25.4
18	8	-3-18M-18M-8M	79.6	39.0	24.4	16.2	6.4	27.0
	10	-3-18M-18M-10M	79.6	39.8	24.4	17.2	7.9	27.0
	12	-3-18M-18M-12M	79.6	39.8	24.4	22.8	9.5	27.0
	14	-3-18M-18M-14M	79.6	39.8	24.4	24.4	11.1	27.0
20	14	-3-20M-20M-14M	89.2	44.6	26.0	24.4	11.1	34.9
22	12	-3-22M-22M-12M	89.2	44.6	26.0	22.8	9.5	34.9
25	12	-3-25M-25M-12M	98.2	44.7	31.3	22.8	9.5	34.9

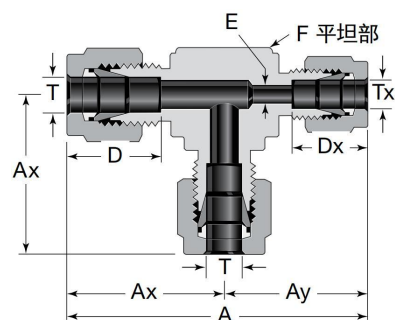

卡套管外径		基本 订购号	尺寸						
T	Tx		A	Ax	Ay	D	Dx	E	F
尺寸, mm									
3/8	1/4	-3-6-4-6	59.5	30.5	29.0	16.8	15.2	4.8	15.9
1/2	1/4	-3-8-4-8	67.9	36.1	31.8	22.9	15.2	4.8	20.6
	3/8	-3-8-6-8	69.4	36.1	33.3	22.9	16.8	7.1	20.6
1	1/2	-3-16-8-16	94	49.3	44.7	31.2	22.9	10.4	34.9
	3/4	-3-16-12-16	94	49.3	44.7	31.2	24.4	15.7	34.9

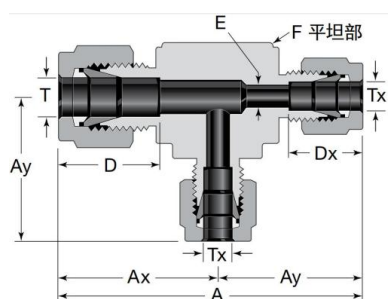

卡套管外径		基本 订购号	尺寸						
T	Tx		A	Ax	Ay	D	Dx	E	F
尺寸, mm									
3/8	1/4	-3-6-4-4	59.5	30.5	29.0	16.8	15.2	4.8	15.9
1/2	1/4	-3-8-4-4	67.9	36.1	31.8	22.9	15.2	4.8	20.6
	3/8	-3-8-6-6	69.4	36.1	33.3	22.9	16.8	7.1	20.6
5/8	3/8	-3-10-6-6	75	38.9	36.1	24.4	16.8	7.1	25.4
	1/2	-3-10-8-8	77.8	38.9	38.9	24.4	22.9	10.4	25.4
3/4	3/8	-3-12-6-6	76.5	39.6	36.9	24.4	16.8	7.1	27.0
	1/2	-3-12-8-8	79.2	39.6	39.6	24.4	22.9	10.4	27.0
	5/8	-3-12-10-10	79.2	39.6	39.6	24.4	24.4	12.7	27.0
7/8	3/4	-3-14-12-12	89.4	44.7	44.7	25.9	24.4	15.7	34.9
1	1/2	-3-16-8-8	94	49.3	44.7	31.2	22.9	10.4	34.9
	7/8	-3-16-14-14	94	49.3	44.7	31.2	25.9	18.3	34.9

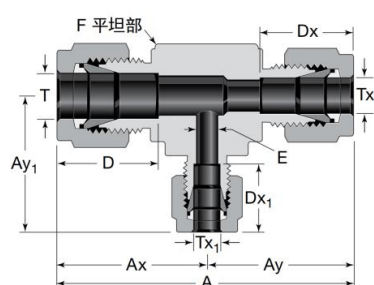

卡套管外径			基本 订购号	尺寸								
T	Tx	Tx1		A	Ax	Ay	Ay1	D	Dx	Dx1	E	F
尺寸, mm												
5/8	3/8	1/2	-3-10-6-8	75	38.9	36.1	38.9	24.4	16.8	22.9	7.1	25.4
5/8	1/2	3/8	-3-10-8-6	77.8	38.9	38.9	36.1	24.4	22.9	16.8	7.1	25.4
3/4	1/2	3/8	-3-12-8-6	79.2	39.6	39.6	36.9	24.4	22.9	16.8	7.1	27.0
3/4	5/8	3/8	-3-12-10-6	79.2	39.6	39.6	36.9	24.4	24.4	16.8	7.1	27.0
3/4	5/8	1/2	-3-12-10-8	79.2	39.6	39.6	39.6	24.4	24.4	22.9	10.4	27.0
7/8	1/2	3/4	-3-14-8-12	89.4	44.7	44.7	44.7	25.9	22.9	24.4	10.4	34.9
7/8	5/8	3/8	-3-14-10-6	89.4	44.7	44.7	41.9	25.9	24.4	16.8	7.1	34.9
7/8	3/4	3/8	-3-14-12-6	89.4	44.7	44.7	41.9	25.9	24.4	16.8	7.1	34.9
7/8	3/4	1/2	-3-14-12-8	89.4	44.7	44.7	44.7	25.9	24.4	22.9	10.4	34.9
1	3/8	3/8	-3-16-6-6	91.2	49.3	41.9	41.9	31.2	16.8	16.8	7.1	34.9
1	1/2	1/4	-3-16-8-4	94	49.3	44.7	40.4	31.2	22.9	15.2	4.8	34.9
1	1/2	3/8	-3-16-8-6	94	49.3	44.7	41.9	31.2	22.9	16.8	7.1	34.9
1	5/8	3/8	-3-16-10-6	94	49.3	44.7	41.9	31.2	24.4	16.8	7.1	34.9
1	3/4	3/8	-3-16-12-6	94	49.3	44.7	41.9	31.2	24.4	16.8	7.1	34.9
1	3/4	1/2	-3-16-12-8	94	49.3	44.7	44.7	31.2	24.4	22.9	10.4	34.9
1	3/4	5/8	-3-16-12-10	94	49.3	44.7	44.7	31.2	24.4	24.4	12.7	34.9
1	7/8	1/4	-3-16-14-4	94	49.3	44.7	40.4	31.2	25.9	15.2	4.8	34.9
1	7/8	3/8	-3-16-14-6	94	49.3	44.7	41.9	31.2	25.9	16.8	7.1	34.9
1	7/8	1/2	-3-16-14-8	94	49.3	44.7	44.7	31.2	25.9	22.9	10.4	34.9
1	7/8	3/4	-3-16-14-12	94	49.3	44.7	44.7	31.2	25.9	24.4	12.7	34.9

## NPT外螺纹三通接头

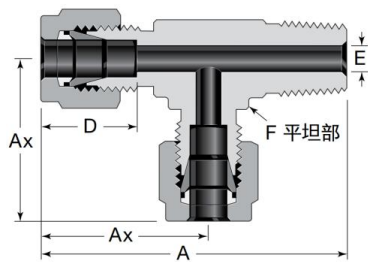

卡套管 外径	NPT 尺寸 in.	基本 订购号	尺寸				
			A	Ax	D	E	F
英制尺寸, mm							
1/8	1/8	-3-2-2NT-2	41.4	23.6	12.7	2.3	11.1
	1/4	-3-2-4NT-2	48	24.6	12.7	2.3	12.7
3/16	1/8	-3-3-2NT-3	42.2	24.4	13.7	3.0	11.1
1/4	1/8	-3-4-2NT-4	45.7	26.9	15.2	4.8	12.7
	1/4	-3-4-4NT-4	50.3	26.9	15.2	4.8	12.7
5/16	1/8	-3-5-2NT-5	50.5	29.7	16.3	4.8	15.9
	1/4	-3-5-4NT-5	55.4	29.7	16.3	6.4	15.9
3/8	1/4	-3-6-4NT-6	55.9	30.5	16.8	7.1	15.9
	3/8	-3-6-6NT-6	61.5	33.3	16.8	7.1	20.6
1/2	3/8	-3-8-6NT-8	64.3	36.1	22.9	9.7	20.6
	1/2	-3-8-8NT-8	69.1	36.1	22.9	10.4	20.6
5/8	1/2	-3-10-8NT-10	73.9	38.1	24.4	11.9	23.8
3/4	3/4	-3-12-12NT-12	76.7	39.9	24.4	15.7	27.0
7/8	3/4	-3-14-12NT-14	82.8	44.7	25.9	15.7	33.3
1	3/4	-3-16-12NT-16	91.5	49.3	31.2	15.7	33.3
	1	-3-16-16NT-16	96	49.3	31.2	22.4	34.9
公制尺寸, mm							
6	1/8	-3-6M-2NT-6M	45	27.0	15.3	4.8	12.7
	1/4	-3-6M-4NT-6M	50.4	27.0	15.3	4.8	12.7
8	1/8	-3-8M-2NT-8M	50.7	29.9	16.2	4.8	15.9
	1/4	-3-8M-4NT-8M	55.3	29.9	16.2	6.4	15.9
10	1/4	-3-10M-4NT-10M	61.7	33.5	17.2	7.9	20.6
	1/2	-3-10M-8NT-10M	61.7	33.5	17.2	7.9	20.6
12	1/4	-3-12M-4NT-12M	64.2	36.0	22.8	7.9	20.6
	3/8	-3-12M-6NT-12M	64.2	36.0	22.8	9.5	20.6
	1/2	-3-12M-8NT-12M	69	36.0	22.8	9.5	20.6
16	1/2	-3-16M-8NT-16M	73	38.0	24.4	11.9	23.8

卡套接头

VCR接头

焊接接头

通用阀门

高纯阀门

卡套管

技术信息

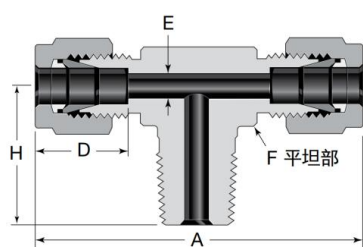

卡套管 外径	NPT 尺寸 in.	基本 订购号	尺寸				
			A	D	E	F	H
英制尺寸, mm							
1/8	1/8	-3-2-2-2NT	47.2	12.7	2.3	11.1	17.8
	1/4	-3-2-2-4NT	49.2	12.7	2.3	12.7	23.4
3/16	1/8	-3-3-3-2NT	48.8	13.7	3.0	11.1	17.8
1/4	1/8	-3-4-4-2NT	53.8	15.2	4.8	12.7	18.8
	1/4	-3-4-4-4NT	53.8	15.2	4.8	12.7	23.4
5/16	1/8	-3-5-5-2NT	59.4	16.3	4.8	15.9	20.8
	1/4	-3-5-5-4NT	59.4	16.3	6.4	15.9	25.7
3/8	1/4	-3-6-6-4NT	61	16.8	7.1	15.9	25.4
	3/8	-3-6-6-6NT	66.6	16.8	7.1	20.6	28.2
1/2	3/8	-3-8-8-6NT	72.2	22.9	9.7	20.6	28.2
	1/2	-3-8-8-8NT	72.2	22.9	10.4	20.6	33.0
5/8	1/2	-3-10-10-8NT	77.8	24.4	11.9	25.4	35.8
3/4	3/4	-3-12-12-12NT	79.8	24.4	15.7	27.0	36.8
7/8	3/4	-3-14-14-12NT	89.4	25.9	15.7	33.3	38.1
1	3/4	-3-16-16-12NT	98.6	31.2	15.7	33.3	42.2
	1	-3-16-16-16NT	98.6	31.2	22.4	34.9	46.7
公制尺寸, mm							
6	1/8	-3-6M-6M-2NT	54	15.3	4.8	12.7	18.8
	1/4	-3-6M-6M-4NT	54	15.3	4.8	12.7	23.4
8	1/8	-3-8M-8M-2NT	59.8	16.2	4.8	15.9	20.8
	1/4	-3-8M-8M-4NT	59.8	16.2	6.4	15.9	25.4
10	1/4	-3-10M-10M-4NT	67	17.2	7.9	20.6	28.2
	3/8	-3-10M-10M-6NT	67	17.2	7.9	20.6	28.2
12	1/4	-3-12M-12M-4NT	72	22.8	7.9	20.6	28.2
	3/8	-3-12M-12M-6NT	72	22.8	9.5	20.6	28.2
	1/2	-3-12M-12M-8NT	72	22.8	9.5	20.6	33.0
16	1/2	-3-16M-16M-8NT	77.6	24.4	11.9	25.4	35.8

## 可定位支管, SAE/MS 直螺纹 (ST) 三通接头

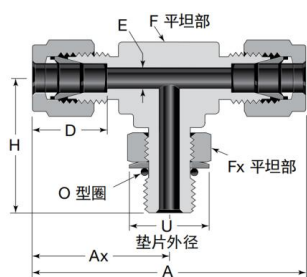

卡套管 外径	SAE/MS 螺纹 尺寸	基本 订购号	尺寸						
			A	Ax	D	E	F	Fx	H
尺寸, mm									
1/4	7/16-20	-3-4-4-7ST	57	28.5	15.2	4.8	12.7	14.3	28.5
3/8	9/16-18	-3-6-6-9ST	64	32.0	16.8	7.1	15.9	17.5	32.3
1/2	3/4-16	-3-8-8-8ST	75.2	37.6	22.9	10.4	20.6	22.2	37.8
3/4	1 1/16-12	-3-12-12-12ST	82.8	41.4	24.4	15.7	27.0	28.6	48.8
1	1 5/16-12	-3-16-16-16ST	101	50.5	31.2	22.4	34.9	38.1	53.6
1 1/4	1 5/8-12	-3-20-20-20ST	135.6	67.8	41.1	27.7	42.9	47.6	58.2
	1 7/8-12	-3-20-20-24ST	156	78.0	50.0	34.0	50.8	54.0	60.5

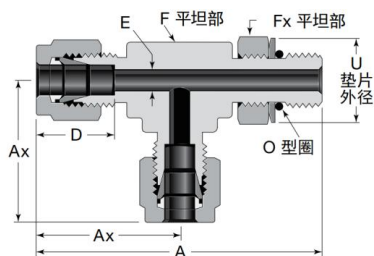

卡套管 外径	SAE/MS 螺纹 尺寸	基本 订购号	尺寸					
			A	Ax	D	E	F	Fx
尺寸, mm								
1/4	7/16-20	-3-4-4ST-4	57	28.5	15.2	4.8	12.7	14.3
3/8	9/16-18	-3-6-6ST-6	64.3	32.0	16.8	7.1	15.9	17.5
1/2	3/4-16	-3-8-8ST-8	75.4	37.6	22.9	10.4	20.6	22.2
3/4	1 1/16-12	-3-12-12ST-12	90.2	41.4	24.4	15.7	27.0	28.6
1	1 5/16-12	-3-16-16ST-16	104.1	50.5	31.2	22.4	34.9	38.1
1 1/4	1 5/8-12	-3-20-20ST-20	126	67.8	41.1	27.7	42.9	47.6
1 1/2	1 7/8-12	-3-24-24ST-24	138.5	78.0	50.0	34.0	50.8	54.0

可定位支管, ISO/BSP 平行螺纹 (PR) 三通接头

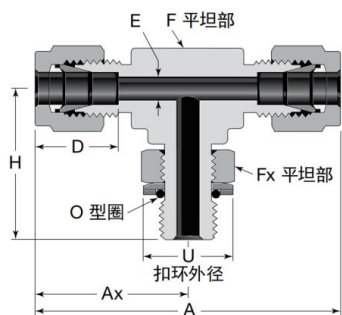

卡套管 外径	ISO 螺纹 尺寸in.	基本 订购号	尺寸						
			A	Ax	D	E	F	Fx	H
英制尺寸, mm									
1/4	1/8	-3-4-4-2PR	53.8	26.9	15.2	4.1	12.7	14.3	26.4
	1/4	-3-4-4-4PR	58	29.0	15.2	4.8	15.9	19.1	32.3
3/8	1/4	-3-6-6-4PR	61	30.5	16.8	5.8	15.9	19.1	32.3
	3/8	-3-8-8-6PR	72.2	36.1	22.9	7.9	20.6	22.2	37.1
1/2	1/2	-3-8-8-8PR	76.2	38.1	22.9	10.4	23.8	27.0	43.4
	5/8	-3-10-10-8PR	76.2	38.1	24.4	11.9	23.8	27.0	43.4
3/4	1/2	-3-12-12-8PR	79.8	39.9	24.4	11.9	27.0	27.0	45.2
	3/4	-3-12-12-12PR	79.8	39.9	24.4	15.7	27.0	34.9	48.8
1	1	-3-16-16-16PR	98	49.0	31.2	19.8	34.9	41.3	53.6
公制尺寸, mm									
6	1/8	-3-6M-6M-2PR	54	27.0	15.3	4.0	12.7	14.3	26.4
	1/4	-3-6M-6M-4PR	58	29.0	15.3	4.8	15.9	19.1	32.2
8	1/8	-3-8M-8M-2PR	57.6	28.8	16.2	4.0	14.3	14.3	27.5
	1/4	-3-8M-8M-4PR	59.8	29.9	16.2	5.9	15.9	19.1	32.2
10	1/4	-3-10M-10M-4PR	67	33.5	17.2	5.9	20.6	19.1	35.1
12	3/8	-3-12M-12M-6PR	72	36.0	22.8	7.9	20.6	22.2	37.1
	1/2	-3-12M-12M-8PR	76	38.0	22.8	9.5	23.8	27.0	43.5

## 可定位支管，ISO/BSP 平行螺纹 (PR) 三通接头

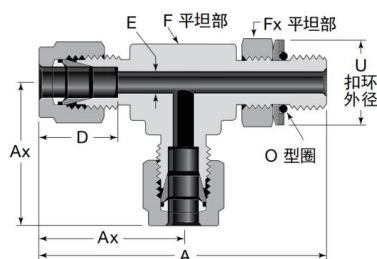

卡套管 外径	ISO 螺纹 尺寸in.	基本 订购号	尺寸					
			A	Ax	D	E	F	Fx
英制尺寸, mm								
1/4	1/8	-3-4-2PR-4	53.3	26.9	15.2	4.1	12.7	14.3
	1/4	-3-4-4PR-4	61.3	29.0	15.2	4.8	15.9	19.1
3/8	1/4	-3-6-4PR-6	62.8	30.5	16.8	5.8	15.9	19.1
1/2	3/8	-3-8-6PR-8	73.2	36.1	22.9	7.9	20.6	22.2
	1/2	-3-8-8PR-8	81.5	38.1	22.9	10.4	23.8	27.0
5/8	1/2	-3-10-8PR-10	81.5	38.1	24.4	11.9	23.8	27.0
3/4	1/2	-3-12-8PR-12	85.1	39.9	24.4	11.9	27.0	27.0
	3/4	-3-12-12PR-12	88.7	39.9	24.4	15.7	27.0	34.9
1	1	-3-16-16PR-16	102.6	49.0	31.2	19.8	34.9	41.3
公制尺寸, mm								
6	1/8	-3-6M-2PR-6M	53.4	27.0	15.3	4.0	12.7	14.3
	1/4	-3-6M-4PR-6M	61.2	29.0	15.3	4.8	15.9	19.1
8	1/8	-3-8M-2PR-8M	56.3	28.8	16.2	4.0	14.3	14.3
	1/4	-3-8M-4PR-8M	62.1	29.9	16.2	5.9	15.9	19.1
10	1/4	-3-10M-4PR-10M	68.6	33.5	17.2	5.9	20.6	19.1
12	3/8	-3-12M-6PR-12M	73.1	36.0	22.8	7.9	20.6	22.2
	1/2	-3-12M-8PR-12M	81.5	38.0	22.8	9.5	23.8	27.0

## NPT内螺纹三通接头

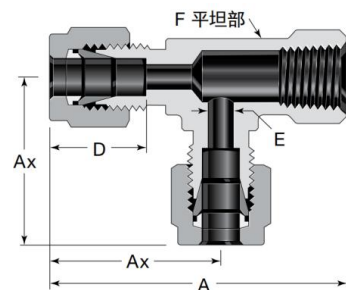

卡套管 外径	NPT 尺寸in.	基本 订购号	尺寸				
			A	Ax	D	E	F
英制尺寸, mm							
1/8	1/8	-3-2-2FNT-2	43.7	24.6	12.7	2.3	12.7
3/16	1/8	-3-3-2FNT-2	44.8	25.7	13.7	3.0	12.7
1/4	1/8	-3-4-2FNT-2	46	26.9	15.2	4.8	12.7
	1/4	-3-4-4FNT-4	52.1	29.7	15.2	4.8	17.5
5/16	1/8	-3-5-2FNT-2	48.8	29.7	16.2	6.4	15.9
3/8	1/4	-3-6-4FNT-4	53.6	31.2	16.8	7.1	17.5
1/2	1/4	-3-8-4FNT-4	58.5	36.1	22.9	10.4	20.6
	3/8	-3-8-6FNT-6	58.5	36.1	22.9	10.4	20.6
	1/2	-3-8-8FNT-8	68.3	39.9	22.9	10.4	27.0
5/8	1/2	-3-10-8FNT-8	68.3	39.9	24.4	12.7	27.0
3/4	3/4	-3-12-12FNT-12	76.5	44.7	24.4	15.7	34.9
7/8	1/2	-3-14-8FNT-8	73.1	44.7	25.9	15.7	34.9
	3/4	-3-14-12FNT-12	76.5	44.7	25.9	18.3	34.9
1	3/4	-3-16-12FNT-12	80.8	49.0	31.2	22.4	34.9
	1	-3-16-16FNT-16	91.7	53.6	31.2	22.4	42.9
公制尺寸, mm							
6	1/8	-3-6M-2FNT-6M	46	27.0	15.3	4.8	12.7
	1/4	-3-6M-4FNT-6M	52.2	29.8	15.3	4.8	17.5
8	1/8	-3-8M-2FNT-8M	48.9	29.9	16.2	4.8	15.9
	1/4	-3-8M-4FNT-8M	53	30.6	16.2	6.4	17.5
10	1/4	-3-10M-4FNT-10M	55.9	33.5	17.2	7.9	20.6
12	1/4	-3-12M-4FNT-12M	58.4	36.0	22.8	9.5	20.6
	3/8	-3-12M-6FNT-12M	59.1	36.0	22.8	9.5	20.6
	1/2	-3-12M-8FNT-12M	67.3	38.8	22.8	9.5	25.4
16	1/2	-3-16M-8FNT-16M	68.2	39.8	24.4	11.9	27.0

## NPT内螺纹三通接头

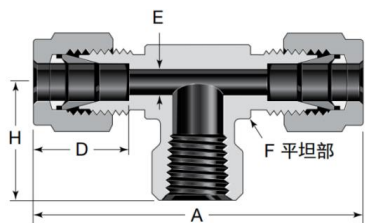

卡套管 外径	NPT 尺寸in.	基本 订购号	尺寸				
			A	D	E	F	H
英制尺寸, mm							
1/8	1/8	-3-2-2-2FNT	49.2	24.6	2.3	12.7	19.1
3/16	1/8	-3-3-3-2FNT	51.4	25.7	3.0	12.7	19.1
1/4	1/8	-3-4-4-2FNT	53.8	26.9	4.8	12.7	19.1
	1/4	-3-4-4-4FNT	59.4	29.7	4.8	17.5	22.4
5/16	1/8	-3-5-5-2FNT	59.4	29.7	6.4	15.9	19.1
3/8	1/4	-3-6-6-4FNT	62.4	31.2	7.1	17.5	22.4
	3/8	-3-6-6-6FNT	66.6	33.3	7.1	20.6	22.4
	1/2	-3-6-6-8FNT	72.2	36.1	7.1	25.4	28.4
1/2	1/4	-3-8-8-4FNT	72.2	36.1	10.4	20.6	22.4
	3/8	-3-8-8-6FNT	72.2	36.1	10.4	20.6	22.4
	1/2	-3-8-8-8FNT	77.8	38.9	10.4	25.4	28.4
5/8	1/2	-3-10-10-8FNT	77.8	38.9	12.7	25.4	28.4
3/4	3/4	-3-12-12-12FNT	89.4	44.7	15.7	34.9	31.8
7/8	3/4	-3-14-14-12FNT	89.4	44.7	18.3	34.9	31.8
1	3/4	-3-16-16-12FNT	98	49.0	22.4	34.9	31.8
	1	-3-16-16-16FNT	107.2	53.6	22.4	42.9	38.1
公制尺寸, mm							
6	1/8	-3-6M-6M-2FNT	54	15.3	4.8	12.7	19.0
	1/4	-3-6M-6M-4FNT	59.6	15.3	4.8	17.5	22.4
8	1/8	-3-8M-8M-2FNT	59.8	16.2	6.4	15.9	19.0
	1/4	-3-8M-8M-4FNT	61.2	16.2	6.4	17.5	22.4
10	1/4	-3-10M-10M-4FNT	67	17.2	7.9	20.6	22.4
12	1/8	-3-12M-12M-2FNT	72	22.8	6.4	20.6	22.3
	1/4	-3-12M-12M-4FNT	72	22.8	9.5	20.6	22.4
	3/8	-3-12M-12M-6FNT	72	22.8	9.5	20.6	22.4
	1/2	-3-12M-12M-8FNT	77.6	22.8	9.5	25.4	28.5
16	1/2	-3-16M-16M-8FNT	77.6	24.4	12.7	25.4	28.4

## 四通接头

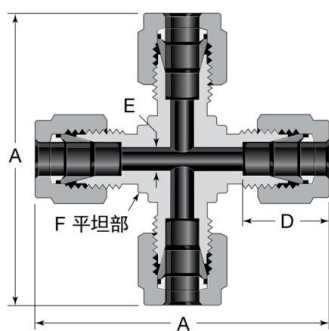

卡套管 外径	基本 订购号	尺寸			
		A	D	E	F
英制尺寸, mm					
1/8	-4-2	44.8	12.7	2.3	9.5
3/16	-4-3	48.8	13.7	3.0	11.1
1/4	-4-4	53.8	15.2	4.8	12.7
5/16	-4-5	59.4	16.2	6.4	15.9
3/8	-4-6	61	16.8	7.1	15.9
1/2	-4-8	72.2	22.9	10.4	20.6
5/8	-4-10	72.6	24.4	12.7	27.0
3/4	-4-12	79.8	24.4	15.7	27.0
7/8	-4-14	89.4	25.9	18.3	34.9
1	-4-16	98	31.2	22.4	34.9
公制尺寸, mm					
3	-4-3M	44.6	12.9	2.4	9.5
4	-4-4M	50.8	13.7	2.4	12.7
6	-4-6M	54	15.3	4.8	12.7
8	-4-8M	59.8	16.2	6.4	15.9
10	-4-10M	67	17.2	7.9	20.6
12	-4-12M	72	22.8	9.5	20.6
16	-4-16M	74	24.4	12.7	23.8
18	-4-18M	76.6	24.4	15.1	27.0
20	-4-20M	89.2	26.0	15.9	34.9
22	-4-22M	89.4	26.0	18.3	34.9
25	-4-25M	98.4	31.3	21.8	34.9

## NPT外螺纹卡套管转换接头

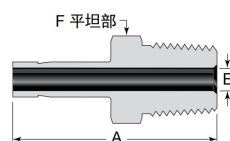

1 in./25 mm 及以下

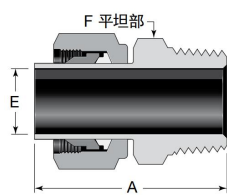

1 in./25 mm 以上

卡套管 外径	NPT 尺寸 in.	基本 订购号	尺寸		
			A	E	F
英制尺寸, in. (mm)					
1/16	1/8	-2-1TB-2NT	1.00 (25.4)	0.03 (0.8)	0.44 (11.1)
1/8	1/8	-2-2TB-2NT	1.16 (29.5)	0.08 (2.0)	0.44 (11.1)
	1/4	-2-2TB-4NT	1.37 (34.8)	0.08 (2.0)	0.56 (14.3)
3/16	1/8	-2-3TB-2NT	1.19 (30.2)	0.12 (3.0)	0.44 (11.1)
	1/4	-2-3TB-4NT	1.40 (35.6)	0.12 (3.0)	0.56 (14.3)
1/4	1/8	-2-4TB-2NT	1.25 (31.8)	0.17 (4.3)	0.44 (11.1)
	1/4	-2-4TB-4NT	1.46 (37.1)	0.17 (4.3)	0.56 (14.3)
	3/8	-2-4TB-6NT	1.49 (37.8)	0.17 (4.3)	0.69 (17.5)
	1/2	-2-4TB-8NT	1.71 (43.4)	0.17 (4.3)	0.87 (22.2)
5/16	1/8	-2-5TB-2NT	1.29 (32.8)	0.19 (4.8)	0.44 (11.1)
	1/4	-2-5TB-4NT	1.50 (38.1)	0.22 (5.6)	0.56 (14.3)
	3/8	-2-5TB-6NT	1.53 (38.9)	0.22 (5.6)	0.69 (17.5)
	1/2	-2-5TB-8NT	1.74 (44.2)	0.22 (5.6)	0.87 (22.2)
3/8	1/8	-2-6TB-2NT	1.32 (33.5)	0.19 (4.8)	0.44 (11.1)
	1/4	-2-6TB-4NT	1.53 (38.9)	0.27 (6.9)	0.56 (14.3)
	3/8	-2-6TB-6NT	1.56 (39.6)	0.27 (6.9)	0.69 (17.5)
	1/2	-2-6TB-8NT	1.78 (45.2)	0.27 (6.9)	0.87 (22.2)
1/2	1/4	-2-8TB-4NT	1.75 (44.5)	0.28 (7.1)	0.56 (14.3)
	3/8	-2-8TB-6NT	1.78 (45.2)	0.37 (9.4)	0.69 (17.5)
	1/2	-2-8TB-8NT	2.00 (50.8)	0.37 (9.4)	0.87 (22.2)
5/8	1/2	-2-10TB-8NT	2.06 (52.3)	0.47 (11.9)	0.87 (22.2)
3/4	1/2	-2-12TB-8NT	2.06 (52.3)	0.47 (11.9)	0.87 (22.2)
	3/4	-2-12TB-12NT	2.06 (52.3)	0.58 (14.7)	1.06 (27.0)
	1	-2-12TB-16NT	2.41 (61.2)	0.81 (20.7)	1.37 (34.9)
1	3/4	-2-16TB-12NT	2.31 (58.7)	0.62 (15.7)	1.06 (27.0)
	1	-2-16TB-16NT	2.60 (66.0)	0.80 (20.3)	1.37 (34.9)
1 1/4	1 1/4	-2-20TB-20NT	3.16 (80.3)	1.02 (25.9)	1.75 (44.5)
1 1/2	1 1/2	-2-24TB-24NT	3.72 (94.5)	1.25 (31.8)	2.13 (54.0)
公制尺寸, in. (mm)					
3	1/8	-2-3MTB-2NT	29.4 (1.16)	1.8 (0.07)	12.0 (0.47)
4	1/8	-2-4MTB-2NT	29.4 (1.16)	2.0 (0.08)	12.0 (0.47)
6	1/8	-2-6MTB-2NT	32.8 (1.29)	4.1 (0.16)	12.0 (0.47)
	1/4	-2-6MTB-4NT	38.1 (1.50)	4.1 (0.16)	14.0 (0.55)
	3/8	-2-6MTB-6NT	39.2 (1.54)	4.1 (0.16)	18.0 (0.71)
	1/2	-2-6MTB-8NT	42.1 (1.66)	4.1 (0.16)	22.0 (0.87)
8	1/4	-2-8MTB-4NT	39.1 (1.54)	5.6 (0.22)	14.0 (0.55)
	3/8	-2-8MTB-6NT	39.9 (1.57)	5.6 (0.22)	19.0 (0.75)
10	1/4	-2-10MTB-4NT	39.9 (1.57)	7.1 (0.28)	14.0 (0.55)
	3/8	-2-10MTB-6NT	40.6 (1.60)	7.1 (0.28)	18.0 (0.71)
	1/2	-2-10MTB-8NT	46.2 (1.82)	7.1 (0.28)	22.0 (0.87)
12	1/4	-2-12MTB-4NT	46.5 (1.83)	7.1 (0.28)	14.0 (0.55)
	3/8	-2-12MTB-6NT	46.2 (1.82)	8.8 (0.35)	18.0 (0.71)
	1/2	-2-12MTB-8NT	52.1 (2.05)	8.8 (0.35)	22.0 (0.87)
16	1/2	-2-16MTB-8NT	50.8 (2.00)	12.7 (0.50)	22.0 (0.87)
	3/4	-2-16MTB-12NT	51.6 (2.03)	12.7 (0.50)	27.0 (1.06)
18	1/2	-2-18MTB-8NT	50.8 (2.00)	12.7 (0.50)	27.0 (1.06)
	3/4	-2-18MTB-12NT	51.6 (2.03)	14.0 (0.55)	27.0 (1.06)
20	1/2	-2-20MTB-8NT	51.8 (2.04)	11.9 (0.47)	22.0 (0.87)
	3/4	-2-20MTB-12NT	52.4 (2.06)	15.1 (0.59)	27.0 (1.06)
25	1	-2-25MTB-16NT	65.9 (2.59)	19.8 (0.78)	35.0 (1.38)
28	1	-2-28MTB-16NT	74.4 (2.93)	22.2 (0.87)	35.0 (1.38)
	1 1/4	-2-28MTB-20NT	76.2 (3.00)	22.5 (0.89)	46.0 (1.81)
30	1	-2-30MTB-16NT	79.2 (3.12)	22.2 (0.87)	41.0 (1.61)
	1 1/4	-2-30MTB-20NT	80.0 (3.15)	24.3 (0.96)	46.0 (1.81)
32	1 1/4	-2-32MTB-20NT	81.0 (3.19)	26.5 (1.04)	46.0 (1.81)
38	1 1/2	-2-38MTB-24NT	92.2 (3.63)	31.6 (1.24)	55.0 (2.17)

## ISO/BSP 锥形螺纹 (RT) 卡套管转换接头

卡套接头

VCR接头

焊接接头

通用阀门

高纯阀门

卡套管

技术信息

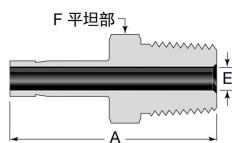

1 in./25 mm 及以下

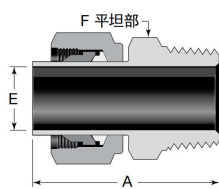

1 in./25 mm 以上

卡套管 外径	ISO 螺纹 尺寸 in.	基本 订购号	尺寸		
			A	E	F
英制尺寸, in. (mm)					
1/8	1/8	-2-2TB-2RT	1.16 (29.5)	0.08 (2.0)	0.44 (11.1)
	1/4	-2-2TB-4RT	1.37 (34.8)	0.08 (2.0)	0.56 (14.3)
1/4	1/8	-2-4TB-2RT	1.25 (31.8)	0.17 (4.3)	0.44 (11.1)
	1/4	-2-4TB-4RT	1.46 (37.1)	0.17 (4.3)	0.56 (14.3)
	3/8	-2-4TB-6RT	1.49 (37.8)	0.17 (4.3)	0.69 (17.5)
	1/2	-2-4TB-8RT	1.71 (43.4)	0.17 (4.3)	0.87 (22.2)
5/16	1/8	-2-5TB-2RT	1.29 (32.8)	0.19 (4.8)	0.44 (11.1)
	1/4	-2-5TB-4RT	1.50 (38.1)	0.22 (5.6)	0.56 (14.3)
3/8	1/4	-2-6TB-4RT	1.53 (38.9)	0.27 (6.9)	0.56 (14.3)
	3/8	-2-6TB-6RT	1.56 (39.6)	0.27 (6.9)	0.69 (17.5)
	1/2	-2-6TB-8RT	1.78 (45.2)	0.27 (6.9)	0.87 (22.2)
1/2	1/4	-2-8TB-4RT	1.75 (44.5)	0.28 (7.1)	0.56 (14.3)
	3/8	-2-8TB-6RT	1.78 (45.2)	0.37 (9.4)	0.69 (17.5)
	1/2	-2-8TB-8RT	2.00 (50.8)	0.37 (9.4)	0.87 (22.2)
5/8	3/8	-2-10TB-6RT	1.91 (48.5)	0.37 (9.5)	0.69 (17.5)
	1/2	-2-10TB-8RT	2.06 (52.3)	0.47 (11.9)	0.87 (22.2)
3/4	3/4	-2-12TB-12RT	2.06 (52.3)	0.58 (14.7)	1.06 (27.0)
1	1	-2-16TB-16RT	2.60 (66.0)	0.80 (20.3)	1.37 (34.9)
公制尺寸, in. (mm)					
3	1/8	-2-3MTB-2RT	29.4 (1.16)	1.8 (0.07)	12.0 (0.47)
4	1/8	-2-4MTB-2RT	29.4 (1.16)	2.0 (0.08)	12.0 (0.47)
6	1/8	-2-6MTB-2RT	32.8 (1.29)	4.1 (0.16)	12.0 (0.47)
	1/4	-2-6MTB-4RT	38.1 (1.50)	4.1 (0.16)	14.0 (0.55)
8	1/4	-2-8MTB-4RT	39.1 (1.54)	5.6 (0.22)	14.0 (0.55)
	3/8	-2-8MTB-6RT	39.9 (1.57)	5.6 (0.22)	18.0 (0.71)
10	1/4	-2-10MTB-4RT	39.9 (1.57)	7.1 (0.28)	14.0 (0.55)
	3/8	-2-10MTB-6RT	40.6 (1.60)	7.1 (0.28)	18.0 (0.71)
	1/2	-2-10MTB-8RT	44.5 (1.75)	7.5 (0.30)	22.0 (0.87)
12	1/4	-2-12MTB-4RT	46.5 (1.83)	7.1 (0.28)	16.0 (0.63)
	3/8	-2-12MTB-6RT	46.2 (1.82)	8.8 (0.35)	18.0 (0.71)
	1/2	-2-12MTB-8RT	51.8 (2.04)	8.8 (0.35)	22.0 (0.87)
16	1/2	-2-16MTB-8RT	50.8 (2.00)	12.7 (0.50)	22.0 (0.87)
18	3/4	-2-18MTB-12RT	51.6 (2.03)	14.0 (0.55)	27.0 (1.06)
20	3/4	-2-20MTB-12RT	52.4 (2.06)	15.1 (0.59)	27.0 (1.06)
25	1	-2-25MTB-16RT	65.9 (2.59)	19.8 (0.78)	35.0 (1.38)
28	1	-2-28MTB-16RT	74.7 (2.94)	22.2 (0.87)	35.0 (1.38)
	1 1/4	-2-28MTB-20RT	76.2 (3.00)	22.5 (0.89)	46.0 (1.81)
30	1 1/4	-2-30MTB-20RT	80.0 (3.15)	24.3 (0.96)	46.0 (1.81)
32	1 1/4	-2-32MTB-20RT	81.0 (3.19)	26.5 (1.04)	46.0 (1.81)
38	1 1/2	-2-38MTB-24RT	92.2 (3.63)	31.6 (1.24)	55.0 (2.17)

## SO/BSP 平行螺纹 (RS) 卡套管转换接头

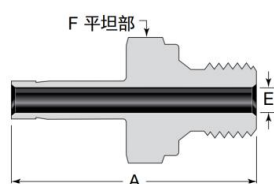

1 in./25 mm 及以下

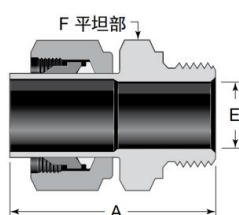

1 in./25 mm 以上

卡套管 外径	ISO 螺纹 尺寸in.	基本 订购号	尺寸		
			A	E	F
英制尺寸, in. (mm)					
1/8	1/8	-2-2TB-2RS	1.22 (31.0)	0.08 (2.0)	0.56 (14.3)
	1/4	-2-2TB-4RS	1.41 (35.8)	0.08 (2.0)	0.75 (19.1)
1/4	1/8	-2-4TB-2RS	1.31 (33.3)	0.16 (4.1)	0.56 (14.3)
	1/4	-2-4TB-4RS	1.50 (38.1)	0.17 (4.3)	0.75 (19.1)
3/8	1/8	-2-6TB-2RS	1.34 (34.0)	0.05 (1.3)	0.56 (14.3)
	1/4	-2-6TB-4RS	1.57 (39.9)	0.23 (5.8)	0.75 (19.1)
	3/8	-2-6TB-6RS	1.60 (40.6)	0.27 (6.9)	0.87 (22.2)
	1/2	-2-6TB-8RS	1.69 (42.9)	0.28 (7.1)	1.06 (27.0)
1/2	1/4	-2-8TB-4RS	1.79 (45.5)	0.23 (5.8)	0.75 (19.1)
	3/8	-2-8TB-6RS	1.82 (46.2)	0.31 (7.9)	0.87 (22.2)
	1/2	-2-8TB-8RS	1.94 (49.2)	0.37 (9.4)	1.06 (27.0)
5/8	1/2	-2-10TB-8RS	1.97 (50.0)	0.47 (11.9)	1.06 (27.0)
3/4	3/4	-2-12TB-12RS	2.16 (54.9)	0.58 (14.7)	1.31 (33.3)
1	1	-2-16TB-16RS	2.54 (64.5)	0.80 (20.3)	1.63 (41.3)
公制尺寸, in. (mm)					
3	1/8	-2-3MTB-2RS	31.0 (1.22)	1.8 (0.07)	14.0 (0.55)
4	1/8	-2-4MTB-2RS	31.8 (1.25)	2.0 (0.08)	14.0 (0.55)
6	1/8	-2-6MTB-2RS	34.3 (1.35)	4.0 (0.16)	14.0 (0.55)
	1/4	-2-6MTB-4RS	39.1 (1.54)	4.1 (0.16)	19.0 (0.75)
8	1/4	-2-8MTB-4RS	40.1 (1.58)	5.6 (0.22)	19.0 (0.75)
10	1/4	-2-10MTB-4RS	40.9 (1.61)	5.9 (0.23)	19.0 (0.75)
	3/8	-2-10MTB-6RS	41.7 (1.64)	7.1 (0.28)	22.0 (0.87)
	1/2	-2-10MTB-8RS	44.7 (1.76)	7.1 (0.28)	27.0 (1.06)
12	1/4	-2-12MTB-4RS	46.7 (1.84)	5.9 (0.23)	19.0 (0.75)
	3/8	-2-12MTB-6RS	47.2 (1.86)	7.9 (0.31)	22.0 (0.87)
	1/2	-2-12MTB-8RS	50.5 (1.99)	8.8 (0.35)	27.0 (1.06)
16	1/2	-2-16MTB-8RS	50.8 (2.00)	11.9 (0.47)	27.0 (1.06)
18	3/4	-2-18MTB-12RS	55.9 (2.20)	13.9 (0.55)	35.0 (1.38)
20	3/4	-2-20MTB-12RS	57.0 (2.24)	15.1 (0.59)	35.0 (1.38)
25	1	-2-25MTB-16RS	65.1 (2.56)	19.8 (0.78)	41.0 (1.61)
28	1	-2-28MTB-16RS	72.9 (2.87)	19.8 (0.78)	41.0 (1.61)
	1 1/4	-2-28MTB-20RS	77.0 (3.03)	22.5 (0.89)	50.0 (1.97)
30	1 1/4	-2-30MTB-20RS	80.8 (3.18)	24.3 (0.96)	50.0 (1.97)
32	1 1/4	-2-32MTB-20RS	81.8 (3.22)	26.5 (1.04)	50.0 (1.97)
38	1 1/2	-2-38MTB-24RS	94.5 (3.72)	31.6 (1.24)	55.0 (2.17)

卡套接头

VCR接头

焊接接头

通用阀门

高纯阀门

卡套管

技术信息

## ISO/BSP 平行螺纹 (RP) 卡套管转换接头

卡套接头

VCR接头

焊接接头

通用阀门

高纯阀门

卡套管

技术信息

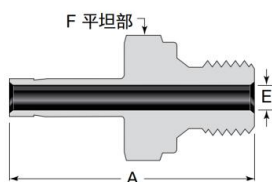

1 in./25 mm 及以下

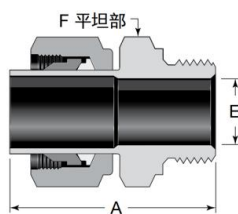

1 in./25 mm 以上

卡套管 外径	ISO 螺纹 尺寸 in.	基本 订购号	尺寸		
			A	E	F
英制尺寸, in. (mm)					
1/8	1/8	-2-2TB-2RP	1.09 (27.7)	0.05 (1.3)	0.56 (14.3)
	1/4	-2-2TB-4RP	1.31 (33.3)	0.05 (1.3)	0.75 (19.1)
1/4	1/8	-2-4TB-2RP	1.19 (30.2)	0.16 (4.1)	0.56 (14.3)
	1/8	-2-4TB-2RP	1.50 (38.1)	0.18 (4.6)	0.75 (19.1)
3/8	1/4	-2-6TB-4RP	1.34 (34.0)	0.05 (1.3)	0.75 (19.1)
	1/4	-2-6TB-4RP	1.47 (37.3)	0.25 (6.4)	0.75 (19.1)
	3/8	-2-6TB-6RP	1.50 (38.1)	0.28 (7.1)	0.87 (22.2)
1/2	1/2	-2-6TB-8RP	1.69 (42.9)	0.28 (7.1)	1.06 (27.0)
	1/4	-2-8TB-4RP	1.69 (42.9)	0.25 (6.4)	0.75 (19.1)
1/2	3/8	-2-8TB-6RP	1.72 (43.7)	0.31 (7.9)	0.87 (22.2)
	1/2	-2-8TB-8RP	1.94 (49.3)	0.39 (9.9)	1.06 (27.0)
5/8	1/2	-2-10TB-8RP	1.97 (50.0)	0.47 (11.9)	1.06 (27.0)
3/4	3/4	-2-12TB-12RP	2.09 (53.1)	0.58 (14.7)	1.32 (33.5)
1	1	-2-16TB-16RP	2.49 (63.3)	0.80 (20.3)	1.63 (41.3)
公制尺寸, in. (mm)					
3	1/8	-2-3MTB-2RP	31.0 (1.22)	1.8 (0.07)	14.0 (0.55)
4	1/8	-2-4MTB-2RP	31.8 (1.25)	2.0 (0.08)	14.0 (0.55)
6	1/8	-2-6MTB-2RP	33.3 (1.31)	4.0 (0.16)	14.0 (0.55)
	1/4	-2-6MTB-4RP	38.1 (1.50)	4.0 (0.16)	19.0 (0.75)
8	1/4	-2-8MTB-4RP	38.9 (1.53)	6.4 (0.25)	19.0 (0.75)
10	1/4	-2-10MTB-4RP	38.9 (1.53)	6.4 (0.25)	19.0 (0.75)
	3/8	-2-10MTB-6RP	39.7 (1.56)	7.5 (0.30)	22.0 (0.87)
	1/2	-2-10MTB-8RP	42.9 (1.69)	7.5 (0.30)	27.0 (1.06)
12	1/4	-2-12MTB-4RP	43.7 (1.72)	6.4 (0.25)	19.0 (0.75)
	3/8	-2-12MTB-6RP	44.5 (1.75)	7.9 (0.31)	22.0 (0.87)
	1/2	-2-12MTB-8RP	49.2 (1.94)	9.1 (0.36)	27.0 (1.06)
16	1/2	-2-16MTB-8RP	50.8 (2.00)	11.9 (0.47)	27.0 (1.06)
18	3/4	-2-18MTB-12RP	53.2 (2.09)	14.0 (0.55)	33.0 (1.30)
20	3/4	-2-20MTB-12RP	54.0 (2.13)	15.1 (0.59)	33.0 (1.30)
25	1	-2-25MTB-16RP	65.1 (2.56)	19.8 (0.78)	41.0 (1.61)
28	1	-2-28MTB-16RP	72.7 (2.86)	19.8 (0.78)	41.0 (1.61)
	1 1/4	-2-28MTB-20RP	77.3 (3.04)	22.5 (0.89)	50.0 (1.97)
30	1 1/4	-2-30MTB-20RP	80.8 (3.18)	24.3 (0.96)	50.0 (1.97)
32	1 1/4	-2-32MTB-20RP	82.1 (3.23)	26.5 (1.04)	50.0 (1.97)
38	1 1/2	-2-38MTB-24RP	94.5 (3.72)	31.6 (1.24)	55.0 (2.17)

## SAE/MS 直螺纹 (ST) 卡套管转换接头

卡套接头

VCR接头

焊接接头

通用阀门

高纯阀门

卡套管

技术信息

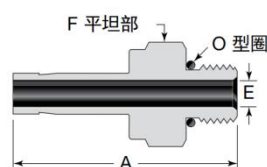

1 in./25 mm 及以下

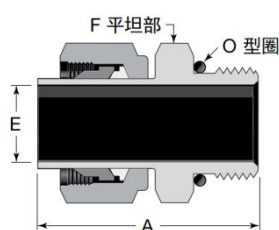

1 in./25 mm 以上

卡套管 外径	SAE/MS 螺纹 尺寸	基本 订购号	尺寸		
			A	E	F
尺寸, in. (mm)					
1/8	5/16-24	-2-2TB-2ST	1.20 (30.5)	0.08 (2.0)	0.44 (11.1)
1/4	7/16-20	-2-4TB-4ST	1.39 (35.3)	0.17 (4.3)	0.56 (14.3)
3/8	7/16-20	-2-6TB-4ST	1.46 (37.1)	0.20 (5.1)	0.56 (14.3)
	9/16-18	-2-6TB-6ST	1.52 (38.6)	0.27 (6.9)	0.69 (17.5)
1/2	3/4-16	-2-6TB-8ST	1.60 (40.6)	0.27 (6.9)	0.87 (22.2)
	9/16-18	-2-8TB-6ST	1.74 (44.2)	0.28 (7.1)	0.69 (17.5)
5/8	3/4-16	-2-8TB-8ST	1.82 (46.2)	0.37 (9.4)	0.87 (22.2)
	7/8-14	-2-10TB-10ST	1.94 (49.3)	0.47 (11.9)	1.00 (25.4)
3/4	1 1/16-12	-2-12TB-12ST	2.10 (53.3)	0.58 (14.7)	1.25 (31.8)
1	1 5/16-12	-2-16TB-16ST	2.41 (61.2)	0.80 (20.3)	1.50 (38.1)
1 1/4	1 5/8-12	-2-20TB-20ST	2.81 (71.4)	1.02 (25.9)	1.87 (47.6)
1 1/2	1 7/8-12	-2-24TB-24ST	3.28 (83.3)	1.25 (31.8)	2.13 (54.0)

## O型圈密封 (SAE/MS 直螺纹) 卡套管转换接头

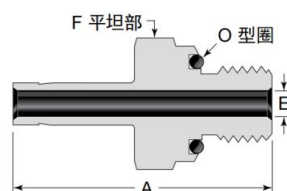

卡套管 外径	SAE/MS 螺纹 尺寸	基本 订购号	尺寸		
			A	E	F
尺寸, in. (mm)					
1/8	5/16-24	-2-2TB-2STO	1.28 (32.5)	0.08 (2.0)	0.56 (14.3)
3/16	3/8-24	-2-3TB-3STO	1.38 (35.1)	0.12 (3.0)	0.63 (15.9)
1/4	7/16-20	-2-4TB-4STO	1.54 (39.1)	0.17 (4.3)	0.75 (19.1)
5/16	1/2-20	-2-5TB-5STO	1.64 (41.7)	0.22 (5.6)	0.87 (22.2)
3/8	9/16-18	-2-6TB-6STO	1.70 (43.2)	0.27 (6.9)	0.94 (23.8)
1/2	3/4-16	-2-8TB-8STO	1.95 (49.5)	0.37 (9.4)	1.13 (28.6)

## AN螺纹卡套管转换接头

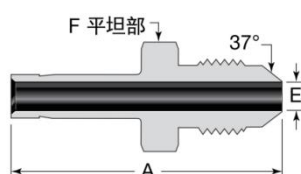

卡套管 外径	AN 卡套管 扩口尺寸	基本 订购号	尺寸		
			A	E	F
尺寸, in. (mm)					
1/4	1/4	-2-4TB-4AN	1.46 (37.1)	0.17 (4.3)	0.50 (12.7)
3/8	1/4	-2-6TB-4AN	1.53 (38.9)	0.17 (4.3)	0.50 (12.7)
3/8	3/8	-2-6TB-6AN	1.56 (39.6)	0.27 (6.9)	0.63 (15.9)
1/2	1/2	-2-8TB-8AN	1.91 (48.5)	0.37 (9.4)	0.81 (20.6)
3/4	3/4	-2-12TB-12AN	2.21 (56.1)	0.58 (14.7)	1.13 (28.6)
1	1	-2-16TB-16AN	2.58 (65.5)	0.80 (20.3)	1.37 (34.9)

# NPT内螺纹卡套管转换接头

卡套接头

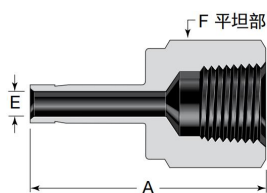

1 in./25 mm 及以下

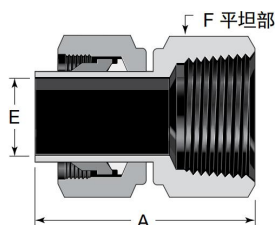

1 in./25 mm 以上

VCR接头

焊接接头

通用阀门

高纯阀门

卡套管

技术信息

卡套管 外径	NPT 尺寸 in.	基本 订购号	尺寸		
			A	E	F
英制尺寸, in. (mm)					
1/16	1/8	-2-1TB-2FNT	1.07 (27.2)	0.03 (0.8)	0.56 (14.3)
1/8	1/8	-2-2TB-2FNT	1.24 (31.5)	0.08 (2.0)	0.56 (14.3)
	1/4	-2-2TB-4FNT	1.39 (35.3)	0.08 (2.0)	0.75 (19.1)
3/16	1/8	-2-3TB-2FNT	1.25 (31.8)	0.11 (2.9)	0.56 (14.3)
	1/4	-2-3TB-4FNT	1.41 (35.8)	0.12 (3.0)	0.75 (19.1)
1/4	1/8	-2-4TB-2FNT	1.30 (33.0)	0.17 (4.3)	0.56 (14.3)
	1/4	-2-4TB-4FNT	1.46 (37.1)	0.17 (4.3)	0.75 (19.1)
	3/8	-2-4TB-6FNT	1.55 (39.4)	0.17 (4.3)	0.87 (22.2)
	1/2	-2-4TB-8FNT	1.79 (45.5)	0.17 (4.3)	1.06 (27.0)
5/16	1/8	-2-5TB-2FNT	1.34 (34.0)	0.22 (5.6)	0.56 (14.3)
	1/4	-2-5TB-4FNT	1.48 (37.6)	0.22 (5.6)	0.75 (19.1)
	3/8	-2-5TB-6FNT	1.59 (40.4)	0.22 (5.6)	0.87 (22.2)
3/8	1/8	-2-6TB-2FNT	1.35 (34.3)	0.27 (6.9)	0.56 (14.3)
	1/4	-2-6TB-4FNT	1.50 (38.1)	0.27 (6.9)	0.75 (19.1)
	3/8	-2-6TB-6FNT	1.59 (40.4)	0.27 (6.9)	0.87 (22.2)
	1/2	-2-6TB-8FNT	1.84 (46.7)	0.27 (6.9)	1.06 (27.0)
1/2	1/4	-2-8TB-4FNT	1.71 (43.4)	0.37 (9.4)	0.75 (19.1)
	3/8	-2-8TB-6FNT	1.79 (45.5)	0.37 (9.4)	0.87 (22.2)
	1/2	-2-8TB-8FNT	2.04 (51.8)	0.37 (9.4)	1.06 (27.0)
5/8	3/8	-2-10TB-6FNT	1.86 (47.2)	0.47 (11.9)	0.87 (22.2)
	1/2	-2-10TB-8FNT	2.09 (53.1)	0.47 (11.9)	1.06 (27.0)
3/4	1/2	-2-12TB-8FNT	2.08 (52.8)	0.58 (14.7)	1.06 (27.0)
	3/4	-2-12TB-12FNT	2.16 (54.9)	0.58 (14.7)	1.31 (33.3)
	1	-2-12TB-16FNT	2.30 (58.4)	0.58 (14.7)	1.63 (41.3)
7/8	3/4	-2-14TB-12FNT	2.22 (56.4)	0.58 (14.7)	1.31 (33.3)
1	3/4	-2-16TB-12FNT	2.39 (60.7)	0.80 (20.3)	1.31 (33.3)
	1	-2-16TB-16FNT	2.53 (64.3)	0.80 (20.3)	1.63 (41.3)
1 1/4	1 1/4	-2-20TB-20FNT	3.06 (77.7)	1.02 (25.9)	2.13 (54.0)
1 1/2	1 1/2	-2-24TB-24FNT	3.50 (88.9)	1.25 (31.8)	2.37 (60.3)
公制尺寸, in. (mm)					
3	1/8	-2-3MTB-2FNT	28.8 (1.13)	1.3 (0.05)	14.0 (0.55)
4	1/8	-2-4MTB-2FNT	33.3 (1.31)	2.0 (0.08)	14.0 (0.55)
6	1/8	-2-6MTB-2FNT	32.5 (1.28)	4.1 (0.16)	14.0 (0.55)
	1/4	-2-6MTB-4FNT	37.1 (1.46)	4.1 (0.16)	19.0 (0.75)
8	1/8	-2-8MTB-2FNT	35.1 (1.38)	6.4 (0.25)	14.0 (0.55)
	1/4	-2-8MTB-4FNT	37.6 (1.48)	5.6 (0.22)	19.0 (0.75)
	3/8	-2-8MTB-6FNT	36.5 (1.44)	6.4 (0.25)	22.0 (0.87)
10	1/4	-2-10MTB-4FNT	38.1 (1.50)	7.1 (0.28)	19.0 (0.75)
	3/8	-2-10MTB-6FNT	40.1 (1.58)	7.1 (0.28)	22.0 (0.87)
	1/2	-2-10MTB-8FNT	46.5 (1.83)	7.1 (0.28)	27.0 (1.06)
12	1/4	-2-12MTB-4FNT	43.7 (1.72)	8.8 (0.35)	19.0 (0.75)
	3/8	-2-12MTB-6FNT	42.9 (1.69)	9.1 (0.36)	22.0 (0.87)
	1/2	-2-12MTB-8FNT	52.3 (2.06)	8.8 (0.35)	27.0 (1.06)
16	1/2	-2-16MTB-8FNT	49.2 (1.94)	12.7 (0.50)	27.0 (1.06)
18	3/4	-2-18MTB-12FNT	52.4 (2.06)	14.0 (0.55)	32.0 (1.26)
20	1/2	-2-20MTB-8FNT	50.0 (1.97)	15.0 (0.59)	27.0 (1.06)
	3/4	-2-20MTB-12FNT	53.2 (2.09)	15.1 (0.59)	32.0 (1.26)
25	1	-2-25MTB-16FNT	66.7 (2.63)	19.8 (0.78)	41.0 (1.61)

## ISO/BSP 锥形螺纹 (RT) 内螺纹卡套管转换接头

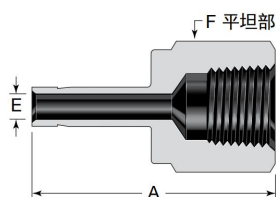

1 in./25 mm 及以下

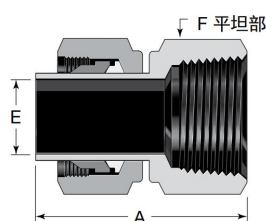

1 in./25 mm 以上

卡套管 外径	ISO 螺纹 尺寸 in.	基本 订购号	尺寸		
			A	E	F
英制尺寸, in. (mm)					
1/4	1/8	-2-4TB-2FRT	1.30 (33.0)	0.17 (4.3)	0.56 (14.3)
	1/4	-2-4TB-4FRT	1.45 (36.8)	0.17 (4.3)	0.75 (19.1)
3/8	1/4	-2-6TB-4FRT	1.50 (38.1)	0.27 (6.9)	0.75 (19.1)
	3/8	-2-6TB-6FRT	1.59 (40.4)	0.27 (6.9)	0.87 (22.2)
1/2	1/4	-2-8TB-4FRT	1.71 (43.4)	0.37 (9.4)	0.75 (19.1)
	3/8	-2-8TB-6FRT	1.80 (45.7)	0.37 (9.4)	0.87 (22.2)
	1/2	-2-8TB-8FRT	2.05 (52.1)	0.37 (9.4)	1.06 (27.0)
公制尺寸, in. (mm)					
3	1/8	-2-3MTB-2FRT	27.8 (1.09)	1.8 (0.07)	14.0 (0.55)
4	1/8	-2-4MTB-2FRT	28.6 (1.13)	2.0 (0.08)	14.0 (0.55)
6	1/8	-2-6MTB-2FRT	33.0 (1.30)	4.1 (0.16)	14.0 (0.55)
8	1/4	-2-8MTB-4FRT	37.6 (1.48)	5.6 (0.22)	19.0 (0.75)
10	1/4	-2-10MTB-4FRT	38.1 (1.50)	7.1 (0.28)	19.0 (0.75)
	3/8	-2-10MTB-6FRT	36.5 (1.44)	7.5 (0.30)	22.0 (0.87)
	1/2	-2-10MTB-8FRT	41.3 (1.63)	7.5 (0.30)	27.0 (1.06)
12	1/4	-2-12MTB-4FRT	40.5 (1.59)	9.1 (0.36)	19.0 (0.75)
	3/8	-2-12MTB-6FRT	43.7 (1.72)	9.1 (0.36)	22.0 (0.87)
	1/2	-2-12MTB-8FRT	46.8 (1.84)	9.1 (0.36)	27.0 (1.06)
16	1/2	-2-16MTB-8FRT	48.4 (1.91)	12.7 (0.50)	27.0 (1.06)
18	3/4	-2-18MTB-12FRT	52.4 (2.06)	14.0 (0.55)	32.0 (1.26)
20	3/4	-2-20MTB-12FRT	53.2 (2.09)	15.1 (0.59)	32.0 (1.26)
25	1	-2-25MTB-16FRT	66.7 (2.63)	19.8 (0.78)	41.0 (1.61)

## ISO/BSP 平行螺纹 (RP) 内螺纹卡套管转换接头

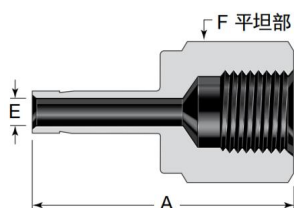

卡套管 外径	ISO 螺纹 尺寸 in.	基本 订购号	尺寸		
			A	E	F
尺寸, in. (mm)					
1/8	1/8	-2-2TB-2FRP	1.17 (29.7)	0.08 (2.0)	0.56 (14.3)
1/4	1/8	-2-4TB-2FRP	1.25 (31.8)	0.17 (4.3)	0.56 (14.3)
	1/4	-2-4TB-4FRP	1.50 (38.1)	0.17 (4.3)	0.75 (19.1)
3/8	1/4	-2-6TB-4FRP	1.55 (39.4)	0.27 (6.9)	0.75 (19.1)
	3/8	-2-6TB-6FRP	1.57 (39.9)	0.27 (6.9)	0.94 (23.8)
1/2	3/8	-2-8TB-6FRP	1.78 (45.2)	0.38 (9.7)	0.94 (23.8)
	1/2	-2-8TB-8FRP	1.95 (49.5)	0.38 (9.7)	1.06 (27.0)

## ISO/BSP 平行螺纹 (RG, 压力表) 内螺纹卡套管转换接头

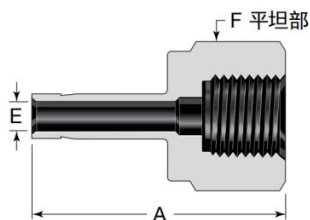

卡套管 外径	ISO 螺纹 尺寸 in.	基本 订购号	尺寸		
			A	E	F
尺寸, in. (mm)					
3	1/8	-2-3MTB-2FRG	28.6 (1.13)	1.6 (0.06)	14.0 (0.55)
	1/4	-2-3MTB-4FRG	33.5 (1.32)	1.9 (0.07)	19.0 (0.75)
4	1/8	-2-4MTB-2FRG	29.4 (1.16)	2.0 (0.08)	14.0 (0.55)
6	1/8	-2-6MTB-2FRG	31.0 (1.22)	4.1 (0.16)	14.0 (0.55)
	1/4	-2-6MTB-4FRG	35.3 (1.39)	4.1 (0.16)	19.0 (0.75)
	3/8	-2-6MTB-6FRG	38.4 (1.51)	4.1 (0.16)	24.0 (0.94)
	1/2	-2-6MTB-8FRG	42.9 (1.69)	4.1 (0.16)	27.0 (1.06)
8	1/4	-2-8MTB-4FRG	33.0 (1.30)	5.5 (0.22)	19.0 (0.75)
	3/8	-2-8MTB-6FRG	38.9 (1.53)	5.6 (0.22)	24.0 (0.94)
	1/2	-2-8MTB-8FRG	43.7 (1.72)	5.6 (0.22)	27.0 (1.06)
10	1/4	-2-10MTB-4FRG	34.5 (1.36)	5.5 (0.22)	19.0 (0.75)
	3/8	-2-10MTB-6FRG	36.1 (1.42)	6.5 (0.26)	24.0 (0.94)
	1/2	-2-10MTB-8FRG	41.1 (1.62)	7.1 (0.28)	27.0 (1.06)
12	1/4	-2-12MTB-4FRG	41.1 (1.62)	5.5 (0.22)	19.0 (0.75)
	3/8	-2-12MTB-6FRG	44.7 (1.76)	6.5 (0.26)	24.0 (0.94)
	1/2	-2-12MTB-8FRG	48.8 (1.92)	7.0 (0.28)	27.0 (1.06)
16	1/2	-2-16MTB-8FRG	49.0 (1.93)	7.0 (0.28)	27.0 (1.06)
18	1/2	-2-18MTB-8FRG	49.3 (1.94)	7.0 (0.28)	27.0 (1.06)

## AN 内螺纹卡套管转换接头

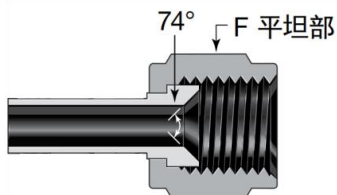

卡套管 外径	AN 卡套管 扩口尺寸	基本 订购号	F
尺寸, in. (mm)			
1/8	1/8	-2-2TB-2FAN	0.37 (9.5)
	1/4	-2-2TB-4FAN	0.56 (14.3)
1/4	1/4	-2-4TB-4FAN	0.56 (14.3)
3/8	3/8	-2-6TB-6FAN	0.69 (17.5)
1/2	1/2	-2-8TB-8FAN	0.87 (22.2)
3/4	3/4	-2-12TB-12FAN	1.25 (31.8)

## 螺母

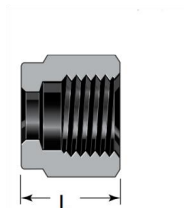

卡套管 外径	基本 订购号	尺寸
		L
英制尺寸, in. (mm)		
1/16	-N-1	0.31 (7.9)
1/8	-N-2	0.47 (11.9)
3/16	-N-3	0.47 (11.9)
1/4	-N-4	0.50 (12.7)
5/16	-N-5	0.53 (13.5)
3/8	-N-6	0.56 (14.2)
1/2	-N-8	0.69 (17.5)
5/8	-N-10	0.69 (17.5)
3/4	-N-12	0.69 (17.5)
7/8	-N-14	0.69 (17.5)
1	-N-16	0.81 (20.6)
1 1/8	-N-18	1.21 (30.8)
1 1/4	-N-20	1.25 (31.8)
1 1/2	-N-24	1.50 (38.1)

卡套管 外径	基本 订购号	尺寸
		L
公制尺寸, in. (mm)		
2	-N-2M	11.9 (0.47)
3	-N-3M	11.9 (0.47)
4	-N-4M	11.9 (0.47)
6	-N-6M	12.7 (0.50)
8	-N-8M	13.5 (0.53)
10	-N-10M	15.1 (0.59)
12	-N-12M	17.4 (0.69)
14	-N-14M	17.4 (0.69)
15	-N-15M	17.4 (0.69)
16	-N-16M	17.4 (0.69)
18	-N-18M	17.4 (0.69)
20	-N-20M	17.4 (0.69)
22	-N-22M	17.4 (0.69)
25	-N-25M	20.6 (0.81)
28	-N-28M	30.6 (1.20)
30	-N-30M	32.7 (1.29)
32	-N-32M	34.4 (1.35)
38	-N-38M	40.6 (1.60)

## 前卡套



卡套管 外径	基本 订购号
尺寸, in.	
1/16	-FF-1
1/8	-FF-2
3/16	-FF-3
1/4	-FF-4
5/16	-FF-5
3/8	-FF-6
1/2	-FF-8
5/8	-FF-10
3/4	-FF-12
7/8	-FF-14
1	-FF-16
1 1/8	-FF-18
1 1/4	-FF-20
1 1/2	-FF-24

卡套管 外径	基本 订购号
尺寸, mm	
2	-FF-2M
3	-FF-3M
4	-FF-4M
6	-FF-6M
8	-FF-8M
10	-FF-10M
12	-FF-12M
14	-FF-14M
15	-FF-15M
16	-FF-16M
18	-FF-18M
20	-FF-20M
22	-FF-22M
25	-FF-25M
28	-FF-28M
30	-FF-30M
32	-FF-32M
38	-FF-38M

## 后卡套



卡套管 外径	基本 订购号
尺寸, in.	
1/16	-BF-1
1/8	-BF-2
3/16	-BF-3
1/4	-BF-4
5/16	-BF-5
3/8	-BF-6
1/2	-BF-8
5/8	-BF-10
3/4	-BF-12
7/8	-BF-14
1	-BF-16
1 1/8	-BF-18
1 1/4	-BF-20
1 1/2	-BF-24

卡套管 外径	基本 订购号
尺寸, mm	
2	-BF-2M
3	-BF-3M
4	-BF-4M
6	-BF-6M
8	-BF-8M
10	-BF-10M
12	-BF-12M
14	-BF-14M
15	-BF-15M
16	-BF-16M
18	-BF-18M
20	-BF-20M
22	-BF-22M
25	-BF-25M
28	-BF-28M
30	-BF-30M
32	-BF-32M
38	-BF-38M
50	-BF-50M

卡套接头

VCR接头

焊接接头

通用阀门

高纯阀门

卡套管

技术信息

## 螺母卡套组



卡套管 外径	基本 订购号
尺寸, in.	
1/16	-NFS-1
1/8	-NFS-2
3/16	-NFS-3
1/4	-NFS-4
5/16	-NFS-5
3/8	-NFS-6
1/2	-NFS-8
5/8	-NFS-10
3/4	-NFS-12
尺寸, mm	
2	-NFS-2M
3	-NFS-3M
4	-NFS-4M
6	-NFS-6M
8	-NFS-8M
10	-NFS-10M
12	-NFS-12M
14	-NFS-14M
15	-NFS-15M
16	-NFS-16M
18	-NFS-18M

## 卡套组



卡套管 外径	基本 订购号
尺寸, in.	
1/16	-FS-1
1/8	-FS-2
3/16	-FS-3
1/4	-FS-4
5/16	-FS-5
3/8	-FS-6
1/2	-FS-8
尺寸, mm	
2	-FS-2M
3	-FS-3M
4	-FS-4M
6	-FS-6M
8	-FS-8M
10	-FS-10M
12	-FS-12M
14	-FS-14M
15	-FS-15M
16	-FS-16M
18	-FS-18M

卡套接头

VCR接头

焊接接头

通用阀门

高纯阀门

卡套管

技术信息

## 软塑料卡套管插件

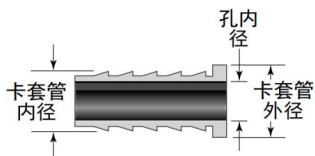

卡套管 外径	卡套管 内径	孔 内径	基本 订购号
英制尺寸, in. (mm)			
3/16	1/8	0.09(2.3)	-Z-3-2
1/4	1/8	0.09(2.3)	-Z-4-2
	0.17	0.11(2.8)	-Z-4-0.17
	3/16	0.14(3.5)	-Z-4-3
5/16	1/8	0.09(2.3)	-Z-5-2
	3/16	0.12(3.0)	-Z-5-3
	1/4	0.19(4.8)	-Z-5-4
3/8	3/16	0.12(3.0)	-Z-6-3
	1/4	0.19(4.8)	-Z-6-4
1/2	1/4	0.19(4.8)	-Z-8-4
	3/8	0.31(7.9)	-Z-8-6
5/8	3/8	0.31(7.9)	-Z-10-6
	1/2	0.44(11.1)	-Z-10-8
3/4	1/2	0.44(11.1)	-Z-12-8
	5/8	0.56(14.2)	-Z-12-10
1	3/4	0.69(17.5)	-Z-16-12
公制尺寸, in. (mm)			
6	4	2.8(0.11)	-Z-6M-4M
8	6	4.4(0.17)	-Z-8M-6M
10	8	6.4(0.25)	-Z-10M-8M
12	8	6.4(0.25)	-Z-12M-8M
	10	8.3(0.33)	-Z-12M-10M

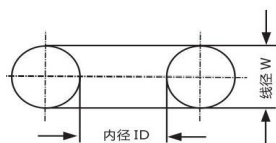

内径	线径	基本 订购号
公制尺寸, mm		
6.90	1.80	FKM-VCO-4
9.50	1.80	FKM-VCO-6

卡套接头

VCR接头

焊接接头

通用阀门

高纯阀门

卡套管

技术信息